

2000 Lakota 300 PARTS DIAGRAM

Brake Pedal

F2260

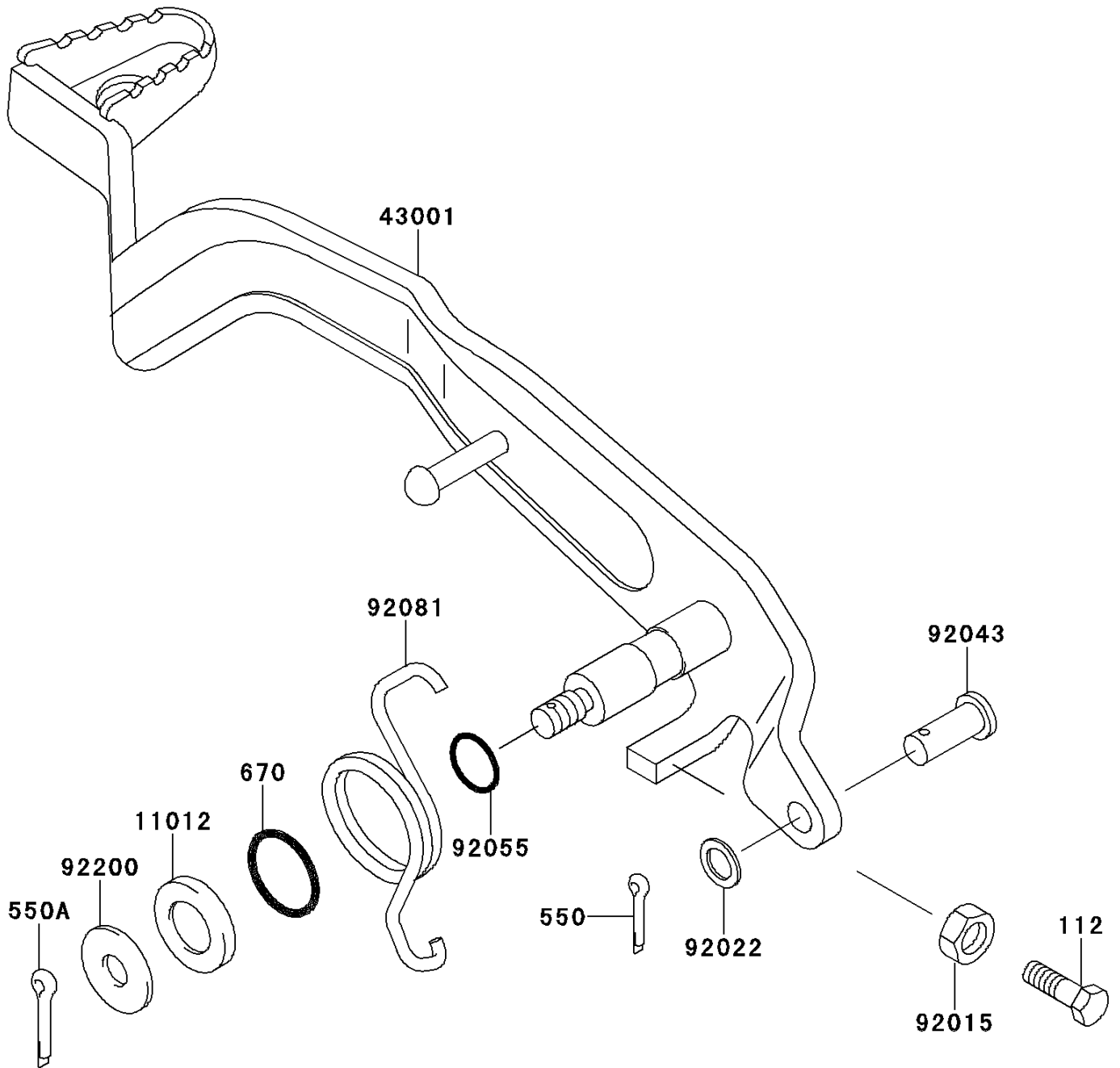

2000 Lakota 300 PARTS LIST

Brake Pedal

ITEM NAME	PART NUMBER	QUANTITY
BOLT-UPSET (Ref # 112)	112D0622	1
PIN-COTTER,2.0X20 (Ref # 550)	550D2020	1
PIN-COTTER,2.5X25 (Ref # 550A)	550D2525	1
O RING,18MM (Ref # 670)	670B2018	1
CAP (Ref # 11012)	11012-1516	1
LEVER-BRAKE,PEDAL,SILVER NO.40 (Ref # 43001)	43001-1350-5A	1
NUT,6MM (Ref # 92015)	92015-1410	1
WASHER,8.5X13X1 (Ref # 92022)	92022-1028	1
PIN (Ref # 92043)	92043-1039	1
RING-O,13.5MM (Ref # 92055)	92055-073	1
SPRING,BRAKE PEDAL RETURN (Ref # 92081)	92081-1996	1
WASHER,8.5X23X1.6 (Ref # 92200)	92200-1156	1