

2017 NINJA® ZX™-10R PARTS DIAGRAM

Oil Pump/Oil Filter

E1710

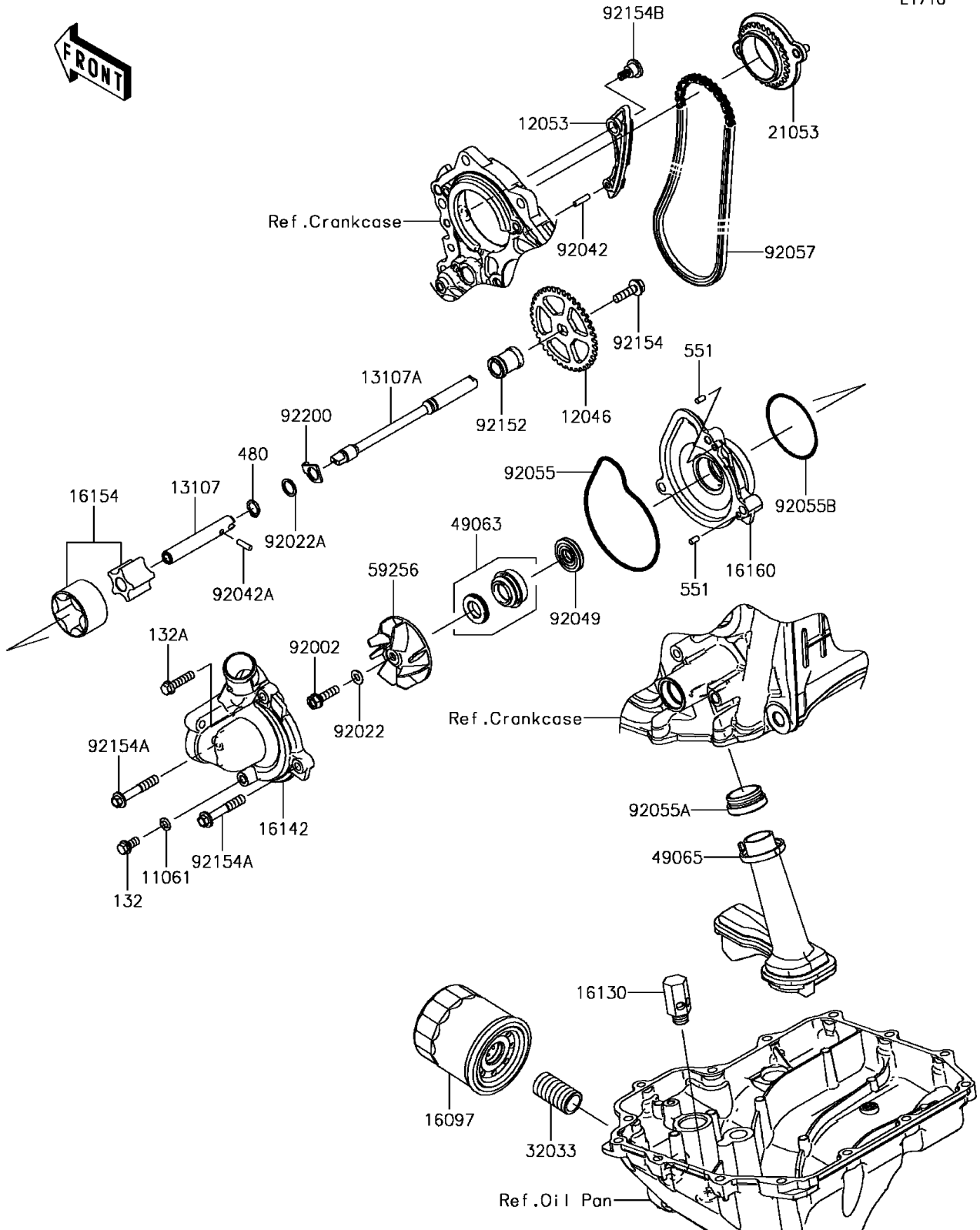

2017 NINJA® ZX™-10R PARTS LIST

Oil Pump/Oil Filter

ITEM NAME	PART NUMBER	QUANTITY
BOLT-FLANGED-SMALL,6X12 (Ref # 132)	132BC0612	1
BOLT-FLANGED-SMALL,6X25 (Ref # 132A)	132BC0625	1
CIRCLIP-TYPE-C,11MM (Ref # 480)	480J1100	1
PIN-DOWEL,4X8 (Ref # 551)	551A0408	2
GASKET (Ref # 11061)	11061-0107	1
SPROCKET,OIL PUMP,38T (Ref # 12046)	12046-0094	1
GUIDE-CHAIN (Ref # 12053)	12053-0181	1
SHAFT,LH (Ref # 13107)	13107-0230	1
SHAFT,RH (Ref # 13107A)	13107-0838	1
FILTER-ASSY-OIL (Ref # 16097)	16097-0011	1
VALVE-ASSY-RELIEF (Ref # 16130)	16130-0005	1
COVER-PUMP,WATER (Ref # 16142)	16142-0734	1
ROTOR-PUMP (Ref # 16154)	16154-0708	1
BODY,WATER PUMP (Ref # 16160)	16160-0226	1
SPROCKET-ASSY,PUMP DRIVE,29T (Ref # 21053)	21053-0007	1
PIPE,OIL FILTER (Ref # 32033)	32033-1535	1
SEAL-MECHANICAL,WATER (Ref # 49063)	49063-1055	1
FILTER-OIL (Ref # 49065)	49065-0042	1
IMPELLER (Ref # 59256)	59256-0011	1
BOLT,6X22 (Ref # 92002)	92002-1154	1
WASHER,6.1X12X1 (Ref # 92022)	92022-077	1
WASHER,11.2X15X1 (Ref # 92022A)	92022-311	1
PIN,DOWEL,4X15.8 (Ref # 92042)	92042-014	1
PIN,DOWEL,4X13.8 (Ref # 92042A)	92042-030	1
SEAL-OIL (Ref # 92049)	92049-0778	1
RING-O,WATER PUMP (Ref # 92055)	92055-0208	1
RING-O,OIL FILTER (Ref # 92055A)	92055-1503	1
RING-O,52.6X2.4 (Ref # 92055B)	92055-1520	1
CHAIN,PUMP DRIVE (Ref # 92057)	92057-0674	1

2017 NINJA® ZX™-10R PARTS LIST

Oil Pump/Oil Filter

ITEM NAME	PART NUMBER	QUANTITY
COLLAR (Ref # 92152)	92152-0865	1
BOLT,FLANGED,6X22 (Ref # 92154)	92154-0387	1
BOLT,FLANGED,6X40 (Ref # 92154A)	92154-1890	2
BOLT,6MM (Ref # 92154B)	92154-1891	1
WASHER (Ref # 92200)	92200-1771	1