

2017 NINJA® ZX™-10R PARTS DIAGRAM

Radiator

E3032

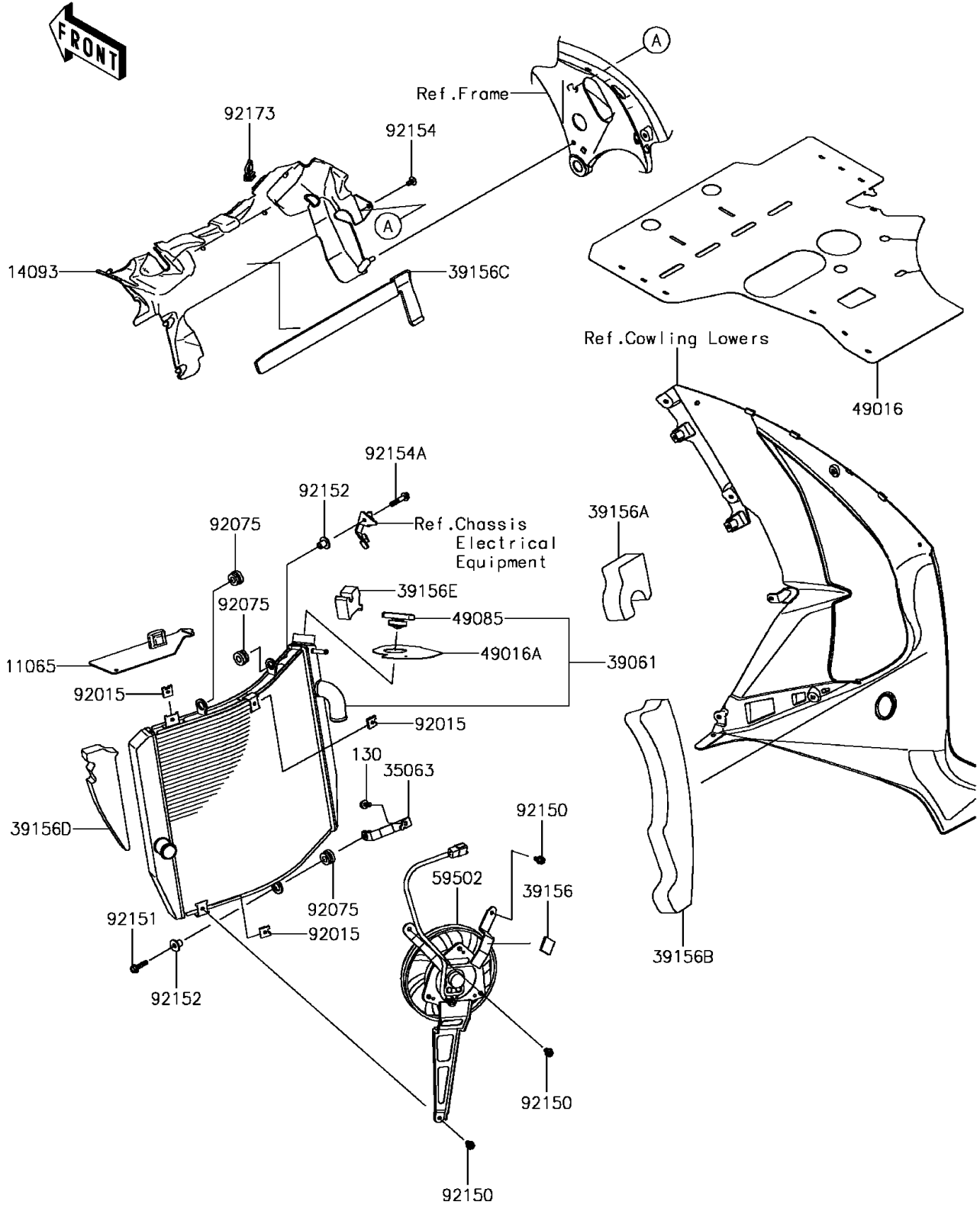

2017 NINJA® ZX™-10R PARTS LIST

Radiator

ITEM NAME	PART NUMBER	QUANTITY
BOLT-FLANGED,6X14 (Ref # 130)	130BA0614	1
CAP (Ref # 11065)	11065-0737	1
COVER (Ref # 14093)	14093-0427	1
STAY (Ref # 35063)	35063-0701	1
RADIATOR-ASSY (Ref # 39061)	39061-0566	1
PAD (Ref # 39156)	39156-0285	1
PAD (Ref # 39156A)	39156-0710	1
PAD (Ref # 39156B)	39156-0724	1
PAD (Ref # 39156C)	39156-0730	1
PAD (Ref # 39156D)	39156-1941	1
PAD (Ref # 39156E)	39156-1976	1
COVER-SEAL,ENGINE RR (Ref # 49016)	49016-0633	1
COVER-SEAL,RH (Ref # 49016A)	49016-0637	1
CAP-ASSY-PRESSURE (Ref # 49085)	49085-1078	1
FAN-ASSY (Ref # 59502)	59502-0606	1
NUT (Ref # 92015)	92015-1487	3
DAMPER,RUBBER (Ref # 92075)	92075-1123	3
BOLT,6X12 (Ref # 92150)	92150-1186	3
BOLT,FLANGED,6X25 (Ref # 92151)	92151-1225	1
COLLAR (Ref # 92152)	92152-1074	2
BOLT,6X12 (Ref # 92154)	92154-1892	1
BOLT,FLANGED,15X30 (Ref # 92154A)	92154-2119	1
CLAMP (Ref # 92173)	92173-1578	1