

2016 Ninja® ZX™-10R PARTS DIAGRAM

Labels

F2860

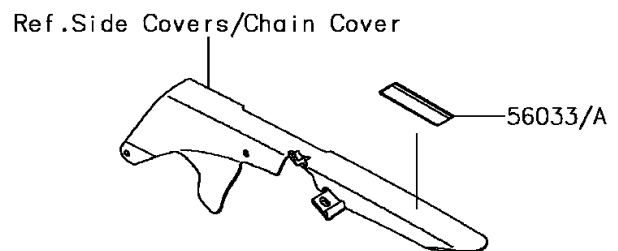
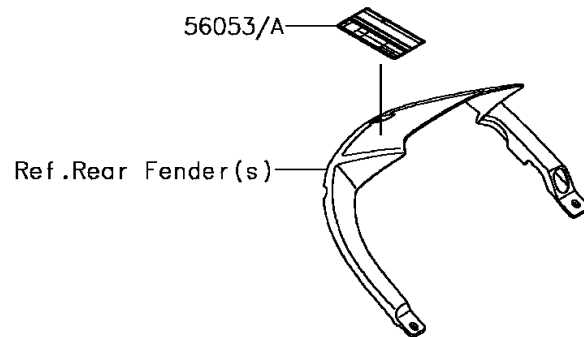
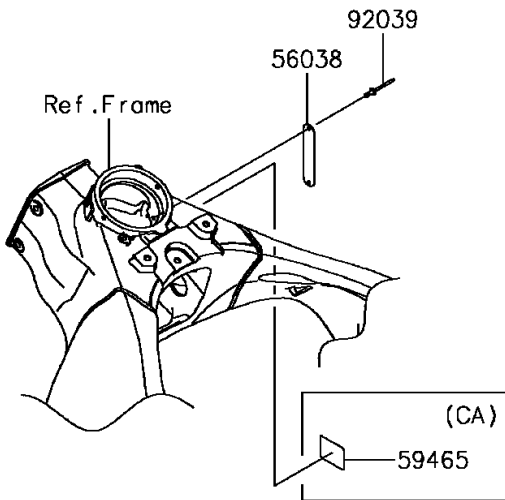
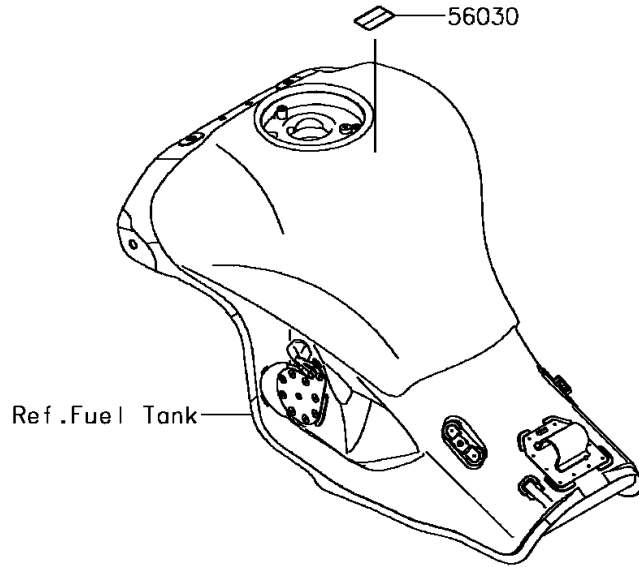
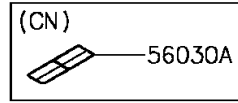
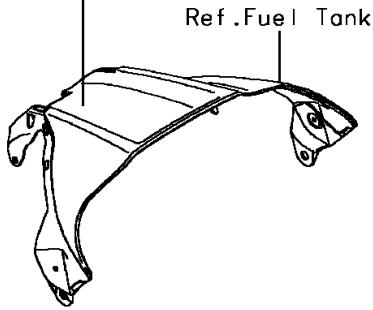
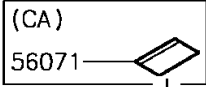

2016 Ninja® ZX™-10R PARTS LIST

Labels

ITEM NAME	PART NUMBER	QUANTITY
LABEL-MANUAL,CHAIN (Ref # 56033)	56033-0927	1
LABEL-BRAND,KAWASAKI (Ref # 56038)	56038-1054	1
LABEL-SPECIFICATION,TIRE&LOAD (Ref # 56053)	56053-0933	1
RIVET (Ref # 92039)	92039-1251	2
LABEL,GASOLINE (Ref # 56030)	56030-0357	1
LABEL,GASOLINE (Ref # 56030A)	56030-0358	1
LABEL-MANUAL,CHAIN (Ref # 56033A)	56033-0935	1
LABEL-SPECIFICATION,TIRE&LOAD (Ref # 56053A)	56053-1178	1
LABEL-WARNING,EVAPO (Ref # 56071)	56071-0158	1
LABEL-CERTIFICATION,EVAPO (Ref # 59465)	59465-2127	1