

# 2003 Lakota Sport PARTS DIAGRAM

Engine Mount

F2122

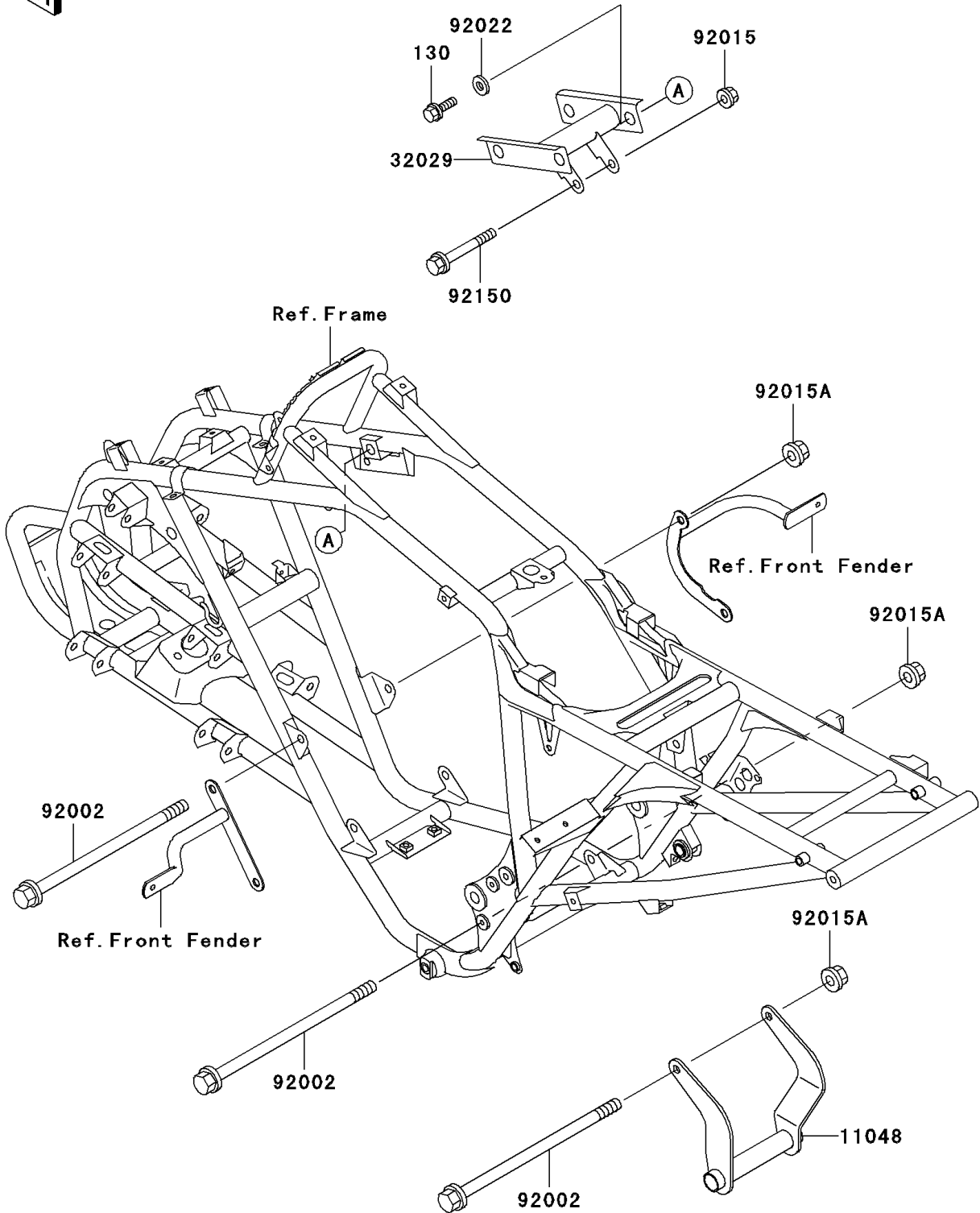

## 2003 Lakota Sport PARTS LIST

### Engine Mount

ITEM NAME	PART NUMBER	QUANTITY
BOLT-FLANGED,8X14 (Ref # 130)	130G0814	4
BRACKET,ENGINE,RR,SILVER NO.40 (Ref # 11048)	11048-1770-5A	1
BRACKET-ENGINE,FR,TOP,BLACK (Ref # 32029)	32029-1933-10	1
BOLT,10X185 (Ref # 92002)	92002-1346	4
NUT,LOCK,FLANGED,8MM (Ref # 92015)	92015-1397	1
NUT,FLANGED,10MM (Ref # 92015A)	92015-1415	4
WASHER,8.5X20X1.6 (Ref # 92022)	92022-1561	4
BOLT,FLANGED,8X65 (Ref # 92150)	92150-1035	1