

2003 Lakota Sport PARTS DIAGRAM

Frame Fittings

F2131

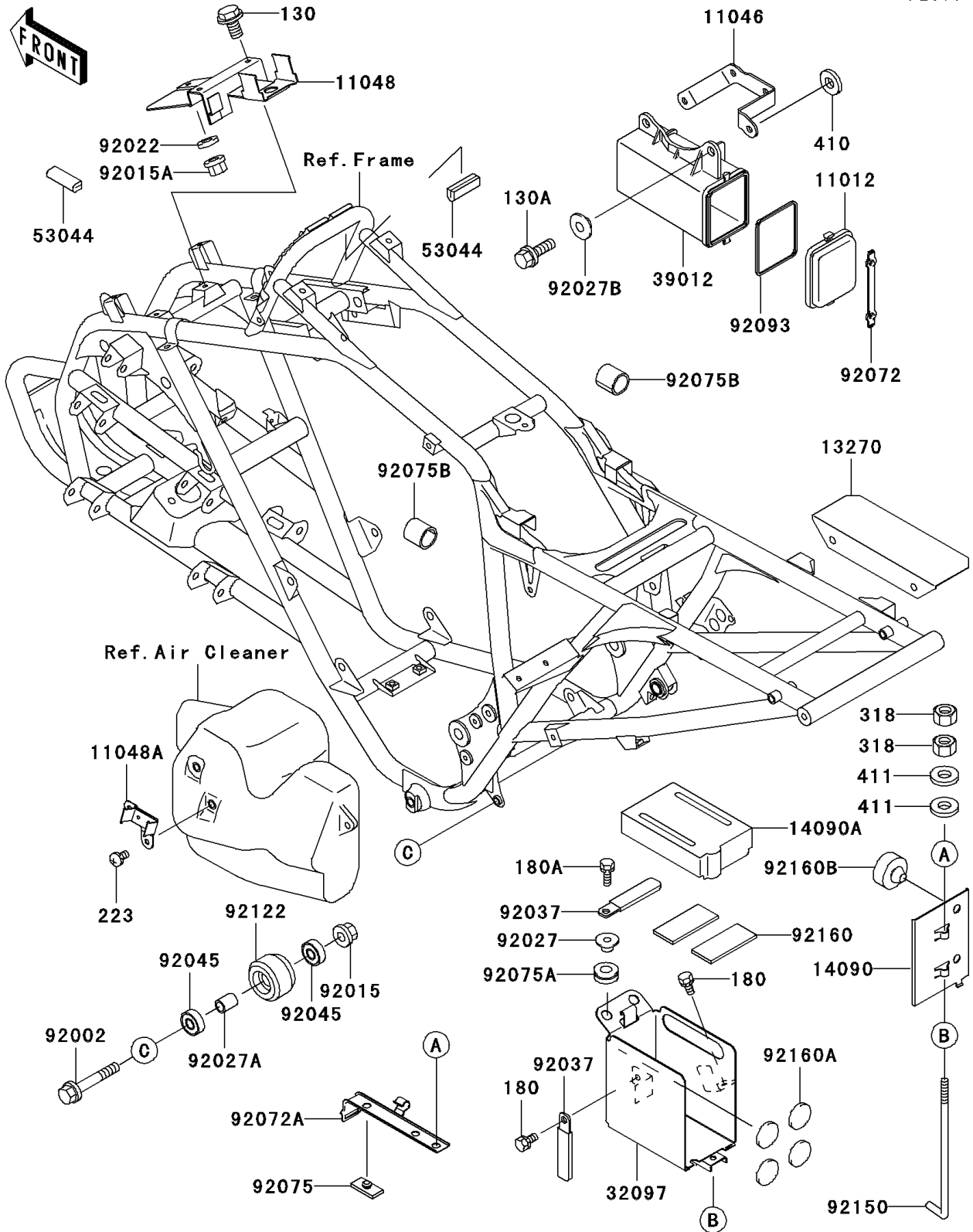

2003 Lakota Sport PARTS LIST

Frame Fittings

ITEM NAME	PART NUMBER	QUANTITY
BOLT-FLANGED,6X10 (Ref # 130)	130B0610	2
BOLT-FLANGED,8X20 (Ref # 130A)	130G0820	2
BOLT-UPSET-WS (Ref # 180)	180D0612	2
BOLT-UPSET-WS (Ref # 180A)	180D0620	2
SCREW-PAN-WS-CROS (Ref # 223)	223C0610	1
NUT-HEX-SMALL (Ref # 318)	318J0800	2
WASHER-PLAIN-SMALL,8MM (Ref # 410)	410B0800	2
WASHER-PLAIN,8MM,BLACK (Ref # 411)	411F0800	2
CAP,TOOL CASE (Ref # 11012)	11012-1606	1
BRACKET,STORAGE CASE (Ref # 11046)	11046-1911	1
BRACKET,ELECTRIC,BLACK (Ref # 11048)	11048-1771-10	1
BRACKET,AIR FILTER (Ref # 11048A)	11048-1772	1
PLATE,MUFFLER (Ref # 13270)	13270-1346	1
COVER,BATTERY (Ref # 14090)	14090-1501	1
COVER (Ref # 14090A)	14090-1573	1
CASE-BATTERY (Ref # 32097)	32097-1155	1
CASE-STORAGE (Ref # 39012)	39012-1055	1
TRIM,L=50 (Ref # 53044)	53044-1185	2
BOLT,FLANGED,8X52 (Ref # 92002)	92002-1857	1
NUT,8MM (Ref # 92015)	92015-1432	1
NUT,LOCK,FLANGED,6MM (Ref # 92015A)	92015-1675	1
WASHER,7X16X1.2 (Ref # 92022)	92022-1344	1
COLLAR,L=9.6 (Ref # 92027)	92027-1045	2
COLLAR,8.8X12X15.5 (Ref # 92027A)	92027-1081	1
COLLAR (Ref # 92027B)	92027-1354	2
CLAMP (Ref # 92037)	92037-1679	2
BEARING-BALL,608DMC3 AV2S (Ref # 92045)	92045-1227	2
BAND,TOOL CASE CAP (Ref # 92072)	92072-1226	1
BAND,BATTERY (Ref # 92072A)	92072-1315	1

2003 Lakota Sport PARTS LIST

Frame Fittings

ITEM NAME	PART NUMBER	QUANTITY
DAMPER (Ref # 92075)	92075-1054	2
DAMPER (Ref # 92075A)	92075-1167	2
DAMPER,25X31X30 (Ref # 92075B)	92075-1906	2
SEAL,TOOL CASE CAP (Ref # 92093)	92093-1247	1
ROLLER,CHAIN GUIDE (Ref # 92122)	92122-1102	1
BOLT,BATTERY (Ref # 92150)	92150-1293	1
DAMPER (Ref # 92160)	92160-1073	2
DAMPER (Ref # 92160A)	92160-1472	4
DAMPER (Ref # 92160B)	92160-3766	2