

2003 Lakota Sport PARTS DIAGRAM

Rear Brake

F2294

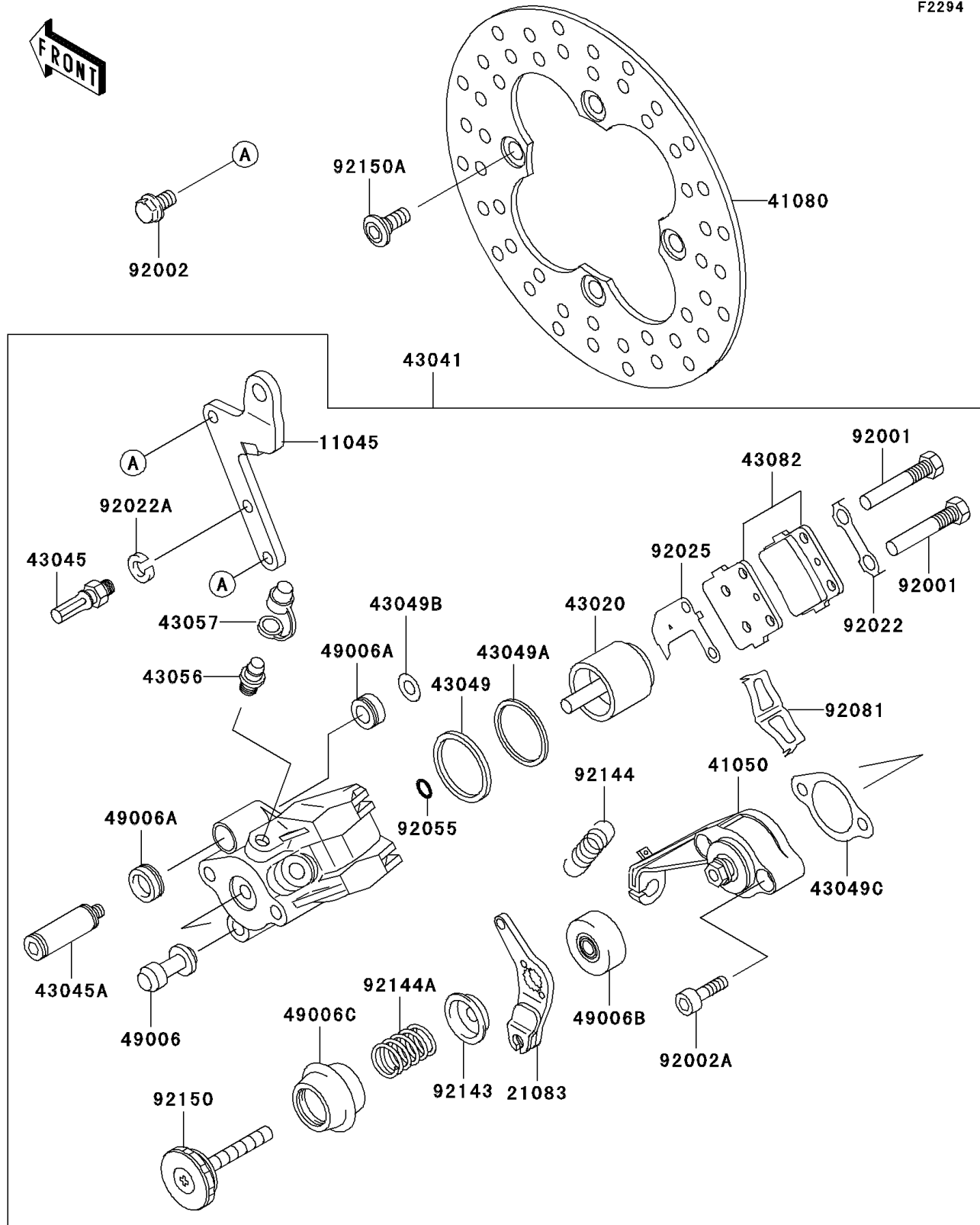

2003 Lakota Sport PARTS LIST

Rear Brake

ITEM NAME	PART NUMBER	QUANTITY
BRACKET (Ref # 11045)	11045-1105	1
ARM (Ref # 21083)	21083-1070	1
CAM-BRAKE,RR CALIPER (Ref # 41050)	41050-1072	1
DISC,RR (Ref # 41080)	41080-1200	1
PISTON-COMP-BRAKE (Ref # 43020)	43020-1102	1
CALIPER-ASSY,RR (Ref # 43041)	43041-1575	1
SHAFT-CALIPER (Ref # 43045)	43045-1010	1
SHAFT-CALIPER (Ref # 43045A)	43045-1051	1
PACKING,PISTON SEAL (Ref # 43049)	43049-1023	1
PACKING,PISTON SEAL (Ref # 43049A)	43049-1024	1
PACKING (Ref # 43049B)	43049-1025	1
PACKING (Ref # 43049C)	43049-1073	1
BREATHER-BRAKE (Ref # 43056)	43056-1055	1
CAP-BREATHER (Ref # 43057)	43057-1001	1
PAD-ASSY-BRAKE (Ref # 43082)	43082-1066	1
BOOT,CALIPER (Ref # 49006)	49006-1088	1
BOOT,CALIPER (Ref # 49006A)	49006-1089	2
BOOT,CALIPER (Ref # 49006B)	49006-1193	1
BOOT,CALIPER (Ref # 49006C)	49006-1232	1
BOLT,PAD HOLDER (Ref # 92001)	92001-1723	2
BOLT,FLANGED,8X13 (Ref # 92002)	92002-1737	2
BOLT (Ref # 92002A)	92002-1772	2
WASHER,LOCK (Ref # 92022)	92022-1372	1
WASHER,WAVE (Ref # 92022A)	92022-1373	1
SHIM,PAD (Ref # 92025)	92025-1344	1
RING-O (Ref # 92055)	92055-1351	1
SPRING,PAD (Ref # 92081)	92081-1502	1
COLLAR (Ref # 92143)	92143-1202	1
SPRING (Ref # 92144)	92144-1037	1

2003 Lakota Sport PARTS LIST

Rear Brake

ITEM NAME	PART NUMBER	QUANTITY
SPRING,ADJUST (Ref # 92144A)	92144-1258	1
BOLT,ADJUST (Ref # 92150)	92150-1080	1
BOLT,SOCKET,8X20 (Ref # 92150A)	92150-1800	4