

# 2002 Lakota Sport PARTS DIAGRAM

Guard(s)

F2680

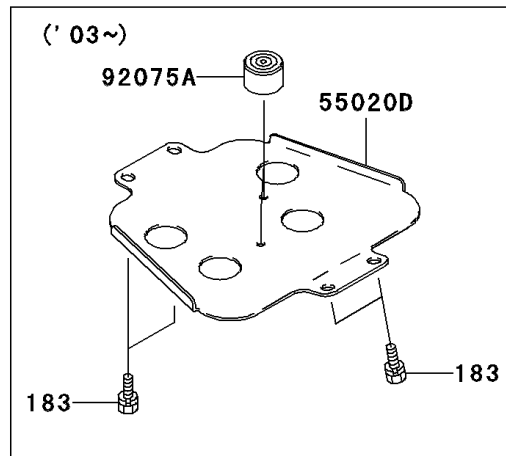
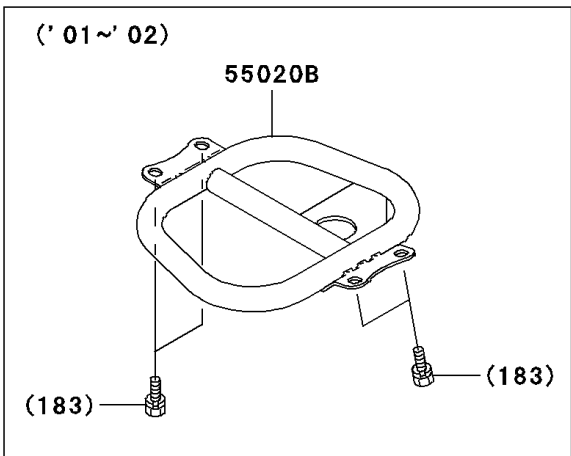
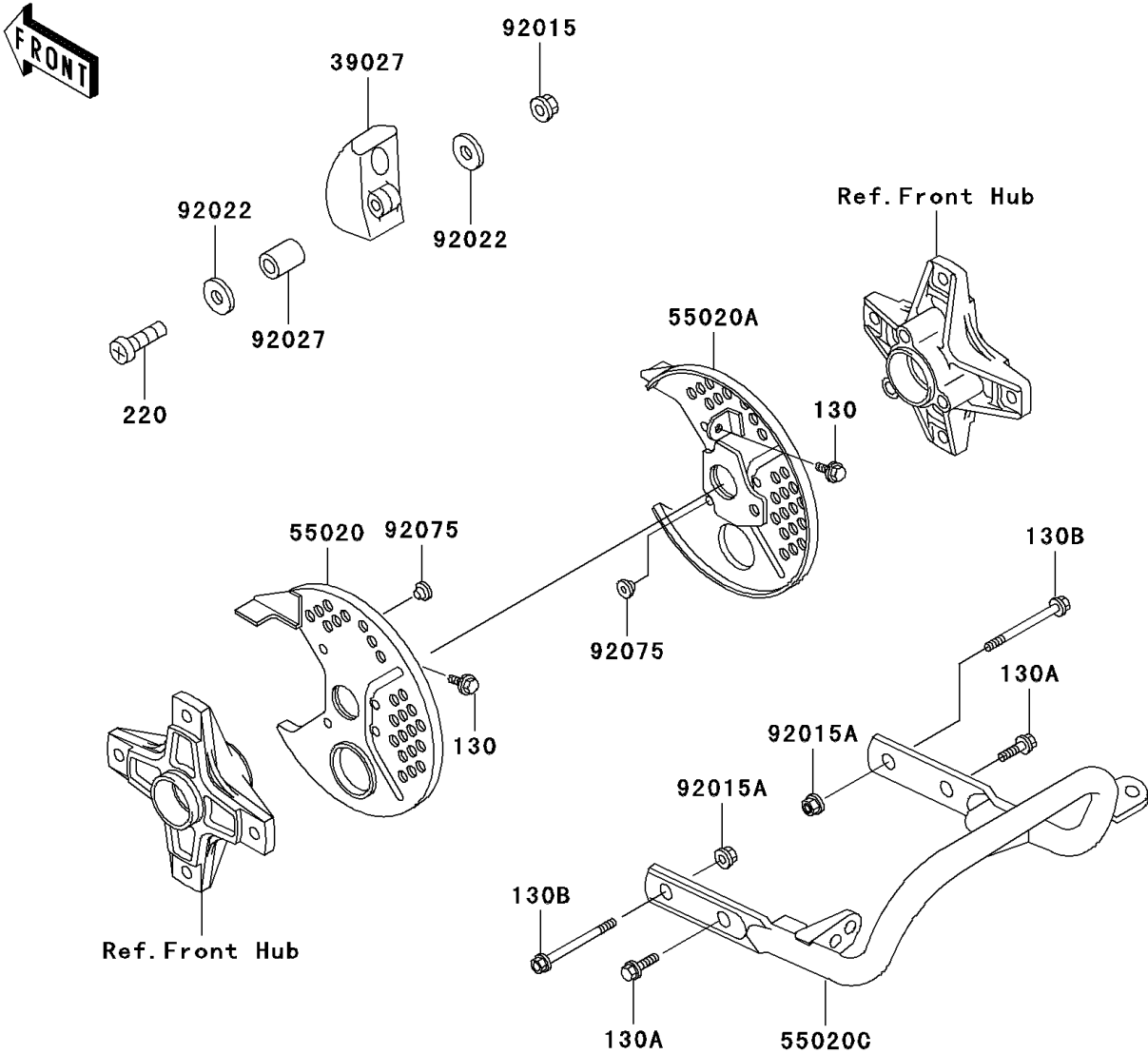

## 2002 Lakota Sport PARTS LIST

Guard(s)

ITEM NAME	PART NUMBER	QUANTITY
BOLT-FLANGED,6X10 (Ref # 130)	130B0610	2
BOLT-FLANGED,8X20 (Ref # 130A)	130G0820	2
BOLT-FLANGED (Ref # 130B)	130Z0865	2
BOLT-UPSET-WS-SMALL (Ref # 183)	183J0814	4
SCREW-PAN-CROS,6X30,BLACK (Ref # 220)	220C0630	2
BUMPER-FRONT (Ref # 39027)	39027-1051	2
GUARD,FRONT HUB,INNER,LH (Ref # 55020)	55020-1223	1
GUARD,FRONT HUB,INNER,RH (Ref # 55020A)	55020-1224	1
GUARD,ENGINE,SILVER NO.40 (Ref # 55020B)	55020-1517-5A	1
GUARD,RR,SILVER (Ref # 55020C)	55020-1704-5A	1
NUT,FLANGED,6MM,BLACK (Ref # 92015)	92015-1233	2
NUT,8MM (Ref # 92015A)	92015-1432	2
WASHER,7X16X1.2 (Ref # 92022)	92022-1344	4
COLLAR,6.8X10X20 (Ref # 92027)	92027-1856	2
DAMPER,INNER (Ref # 92075)	92075-1822	6