

1994 KLR250 PARTS DIAGRAM

Fuel Evaporative System

E1650

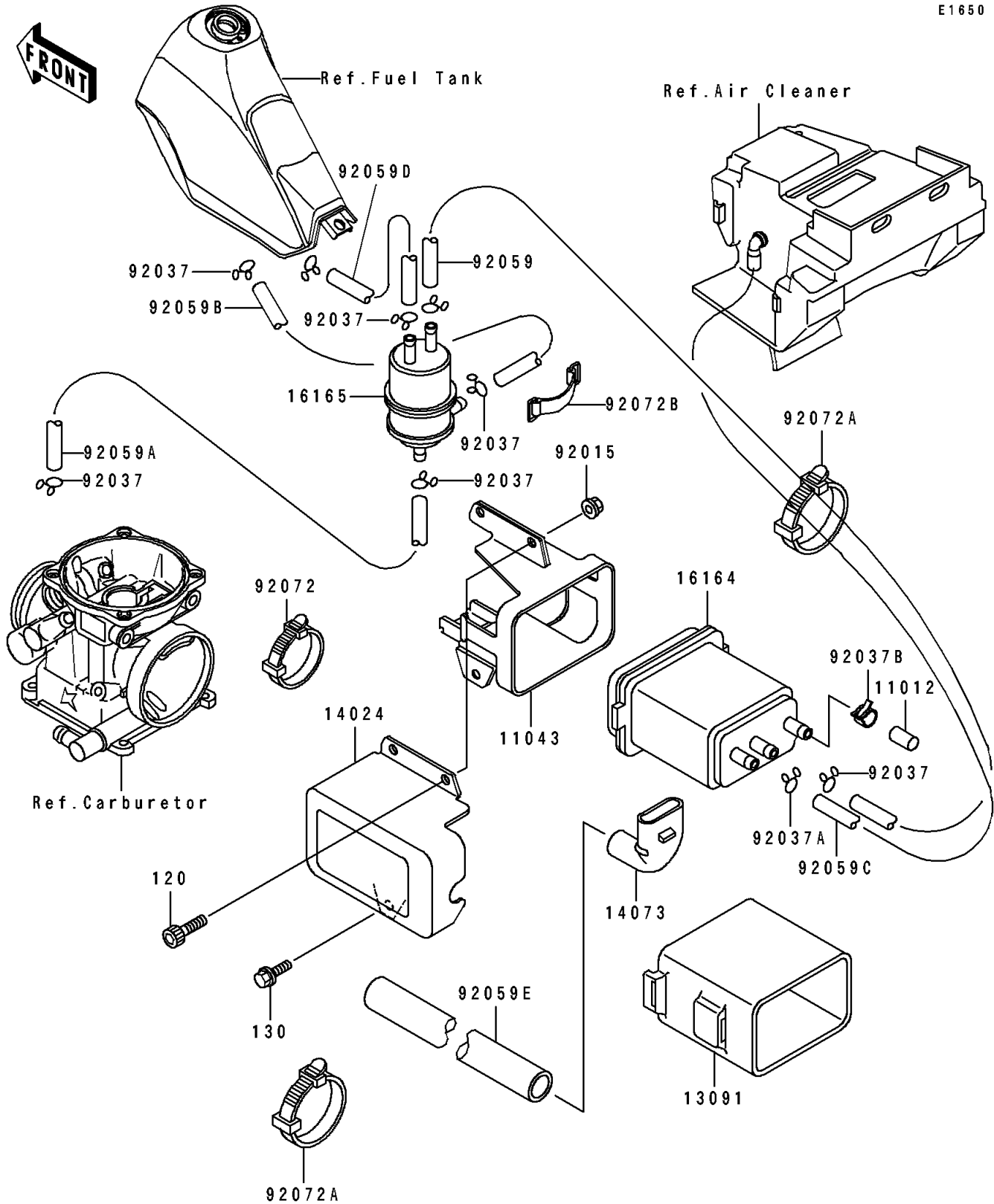

1994 KLR250 PARTS LIST

Fuel Evaporative System

ITEM NAME	PART NUMBER	QUANTITY
CAP,CANISTER (Ref # 11012)	11012-1388	1
BRACKET,CANISTER (Ref # 11043)	11043-1180	1
HOLDER,CANISTER (Ref # 13091)	13091-1176	1
COVER,CANISTER (Ref # 14024)	14024-1063	1
DUCT,CANISTER (Ref # 14073)	14073-1219	1
CANISTER (Ref # 16164)	16164-1001	1
SEPARATOR (Ref # 16165)	16165-1001	1
NUT,6MM (Ref # 92015)	92015-1365	2
CLAMP,TUBE (Ref # 92037)	92037-072	8
CLAMP,HOSE (Ref # 92037A)	92037-1104	1
CLAMP,CANISTER (Ref # 92037B)	92037-1512	1
TUBE,5X9X860,BLUE (Ref # 92059)	92059-1531	1
TUBE,4X9X500,WHITE (Ref # 92059A)	92059-1533	1
TUBE,5X9X430,RED (Ref # 92059B)	92059-1534	1
TUBE,7X12X660,GREEN (Ref # 92059C)	92059-1535	1
TUBE,5X9X255,BLUE (Ref # 92059D)	92059-1536	1
TUBE,14X20X470 (Ref # 92059E)	92059-1571	1
BAND,L=149 (Ref # 92072)	92072-031	1
BAND,L=186 (Ref # 92072A)	92072-056	2
BAND,L=50 (Ref # 92072B)	92072-066	1
BOLT-SOCKET,6X16,BLACK (Ref # 120)	120S0616	2
BOLT-FLANGED (Ref # 130)	130C0608	1