

# 1996 KLR250 PARTS DIAGRAM

Radiator

E3032

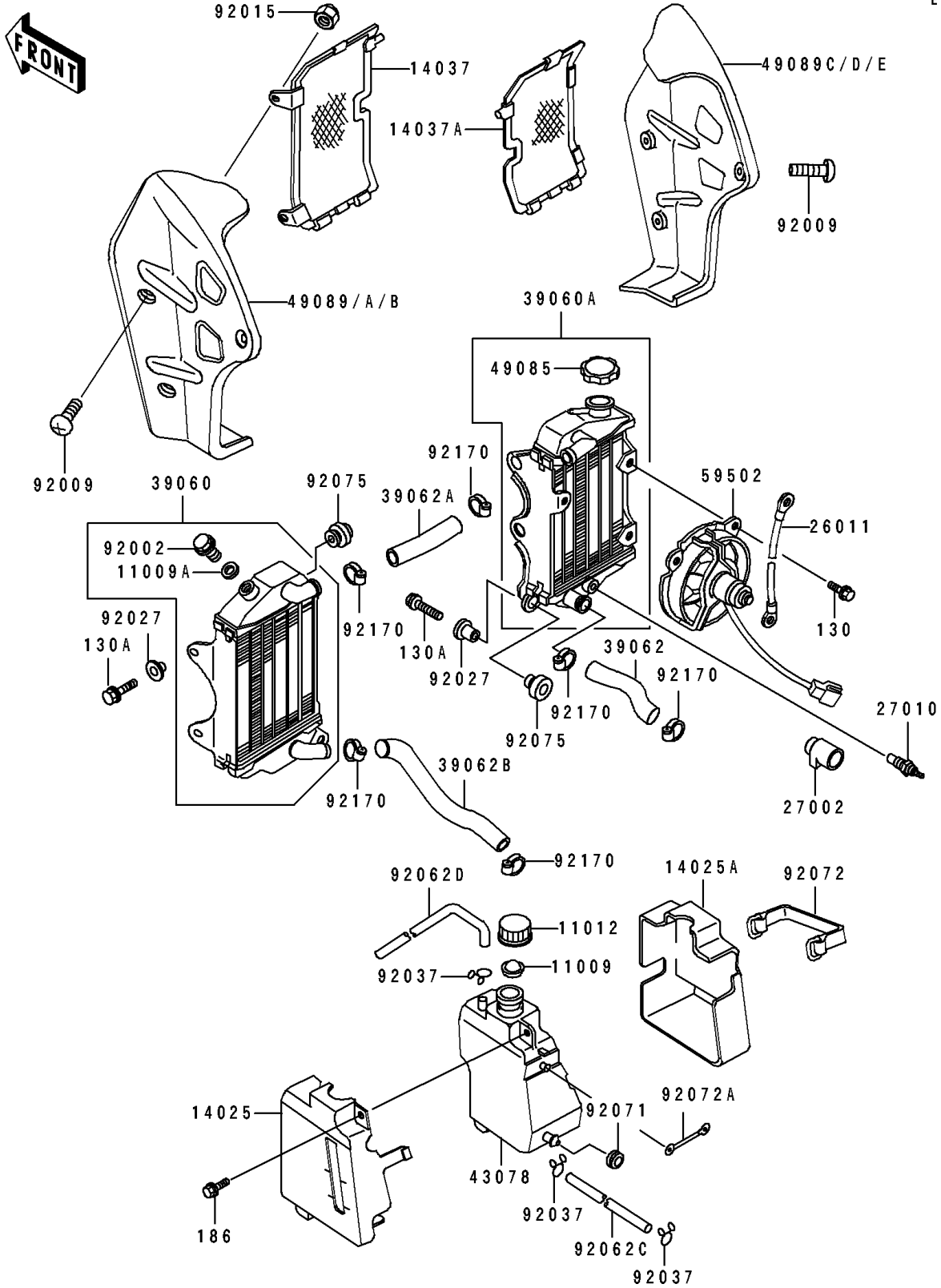

# 1996 KLR250 PARTS LIST

## Radiator

ITEM NAME	PART NUMBER	QUANTITY
GASKET,RESERVOIR TANK CAP (Ref # 11009)	11009-1145	1
GASKET,DRAIN BOLT (Ref # 11009A)	11009-1152	1
CAP (Ref # 11012)	11012-1084	1
COVER,RESERVOIR (Ref # 14025)	14025-1991	1
COVER,RESERVOIR (Ref # 14025A)	14025-1992	1
SCREEN,LH (Ref # 14037)	14037-1061	1
SCREEN,RH (Ref # 14037A)	14037-1062	1
WIRE-LEAD (Ref # 26011)	26011-1278	1
RELAY-ASSY (Ref # 27002)	27002-1051	1
SWITCH,FAN (Ref # 27010)	27010-1180	1
RADIATOR,LH (Ref # 39060)	39060-1060	1
RADIATOR,RH (Ref # 39060A)	39060-1061	1
HOSE-COOLING (Ref # 39062)	39062-1083	1
HOSE-COOLING (Ref # 39062A)	39062-1084	1
HOSE-COOLING (Ref # 39062B)	39062-1085	1
HOSE-COOLING (Ref # 39062C)	39062-1086	1
HOSE-COOLING (Ref # 39062D)	39062-1132	1
RESERVOIR,TANK (Ref # 43078)	43078-1061	1
CAP-ASSY-PRESSURE (Ref # 49085)	49085-1067	1
SHROUD-ENGINE,LH,GREEN 15 (Ref # 49089)	49089-1057-51	1
SHROUD-ENGINE,RH,GREEN 15 (Ref # 49089C)	49089-1058-51	1
FAN-ASSY (Ref # 59502)	59502-1052	1
BOLT,RADIATOR DRAIN (Ref # 92002)	92002-1682	1
SCREW,6X14,WHITE (Ref # 92009)	92009-1287	6
NUT,CAP,6MM,BLACK (Ref # 92015)	92015-1170	4
COLLAR (Ref # 92027)	92027-1183	6
CLAMP,TUBE (Ref # 92037)	92037-147	3
GROMMET (Ref # 92071)	92071-1115	1
BAND,L=82 (Ref # 92072)	92072-053	1

# 1996 KLR250 PARTS LIST

## Radiator

ITEM NAME	PART NUMBER	QUANTITY
BAND,L=58 (Ref # 92072A)	92072-1156	1
DAMPER (Ref # 92075)	92075-1352	6
CLAMP,COOLING HOSE (Ref # 92170)	92170-1033	6
BOLT-FLANGED (Ref # 130)	130J0612	3
BOLT-FLANGED (Ref # 130A)	130J0620	6
BOLT-UPSET-WP (Ref # 186)	186J0618	1