

1996 KLR250 PARTS DIAGRAM

Fenders

F2170

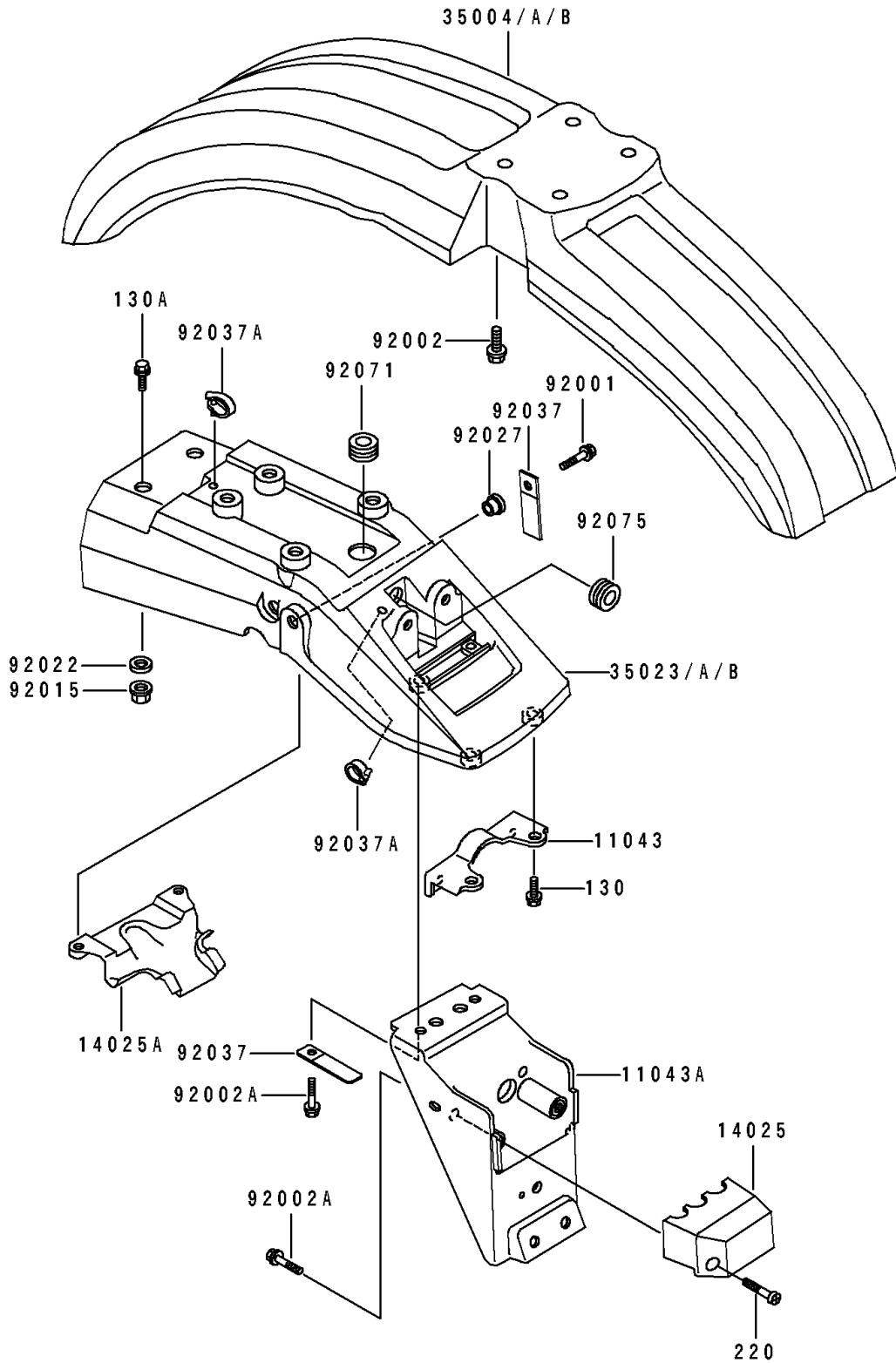

1996 KLR250 PARTS LIST

Fenders

ITEM NAME	PART NUMBER	QUANTITY
BRACKET,REAR FLAP (Ref # 11043)	11043-1734	1
BRACKET (Ref # 11043A)	11043-1827	1
COVER,LICENSE PLATE LAMP (Ref # 14025)	14025-1933	1
COVER,HARNESS (Ref # 14025A)	14025-1982	1
FENDER-FRONT,GREEN 15 (Ref # 35004)	35004-1153-51	1
FENDER-REAR,RR,GREEN 15 (Ref # 35023)	35023-1114-51	1
BOLT,6X20 (Ref # 92001)	92001-1773	2
BOLT,6X16 (Ref # 92002)	92002-1187	4
BOLT,6X16 (Ref # 92002A)	92002-1188	4
NUT,FLANGED,6MM (Ref # 92015)	92015-1367	2
WASHER,6.5X20X1.6 (Ref # 92022)	92022-1557	2
COLLAR,L=4.7 (Ref # 92027)	92027-122	2
CLAMP,WIRING HARNESS (Ref # 92037)	92037-1069	2
CLAMP,HOSE (Ref # 92037A)	92037-1163	2
GROMMET (Ref # 92071)	92071-1027	1
DAMPER (Ref # 92075)	92075-1028	1
BOLT-FLANGED (Ref # 130)	130D0608	2
BOLT-FLANGED (Ref # 130A)	130D0612	2
SCREW-PAN-CROS (Ref # 220)	220C0545	2