

2015 KLR650 PARTS DIAGRAM

Gear Change Drum/Shift Fork(s)

E1362

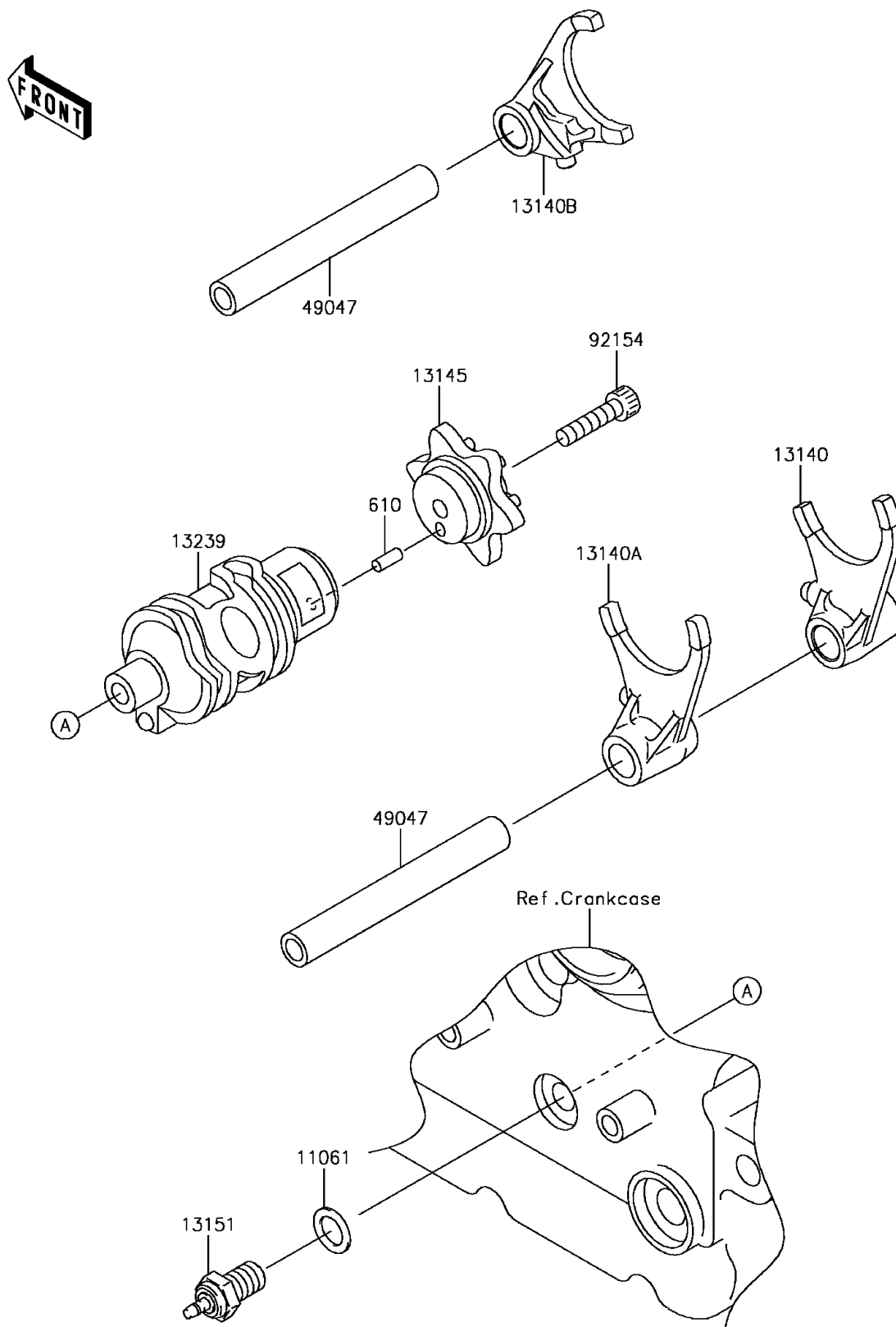

2015 KLR650 PARTS LIST

Gear Change Drum/Shift Fork(s)

| ITEM NAME | PART NUMBER | QUANTITY |
|--|-------------|----------|
| ROLLER,4X10 (Ref # 610) | 610A0410 | 1 |
| GASKET,10.5X16X1 (Ref # 11061) | 11061-0373 | 1 |
| FORK-SHIFT,LOW (Ref # 13140) | 13140-1023 | 1 |
| FORK-SHIFT,2ND&3RD (Ref # 13140A) | 13140-1024 | 1 |
| FORK-SHIFT,4TH&TOP,36MM (Ref # 13140B) | 13140-1288 | 1 |
| CAM-CHANGE DRUM (Ref # 13145) | 13145-0050 | 1 |
| SWITCH-COMP,NEUTRAL (Ref # 13151) | 13151-1102 | 1 |
| DRUM-ASSY-CHANGE (Ref # 13239) | 13239-1103 | 1 |
| ROD-SHIFT,L=93.7 (Ref # 49047) | 49047-0039 | 2 |
| BOLT,SOCKET,6X25 (Ref # 92154) | 92154-0477 | 1 |