

1999 KLR250 PARTS DIAGRAM

Crankshaft

E1321

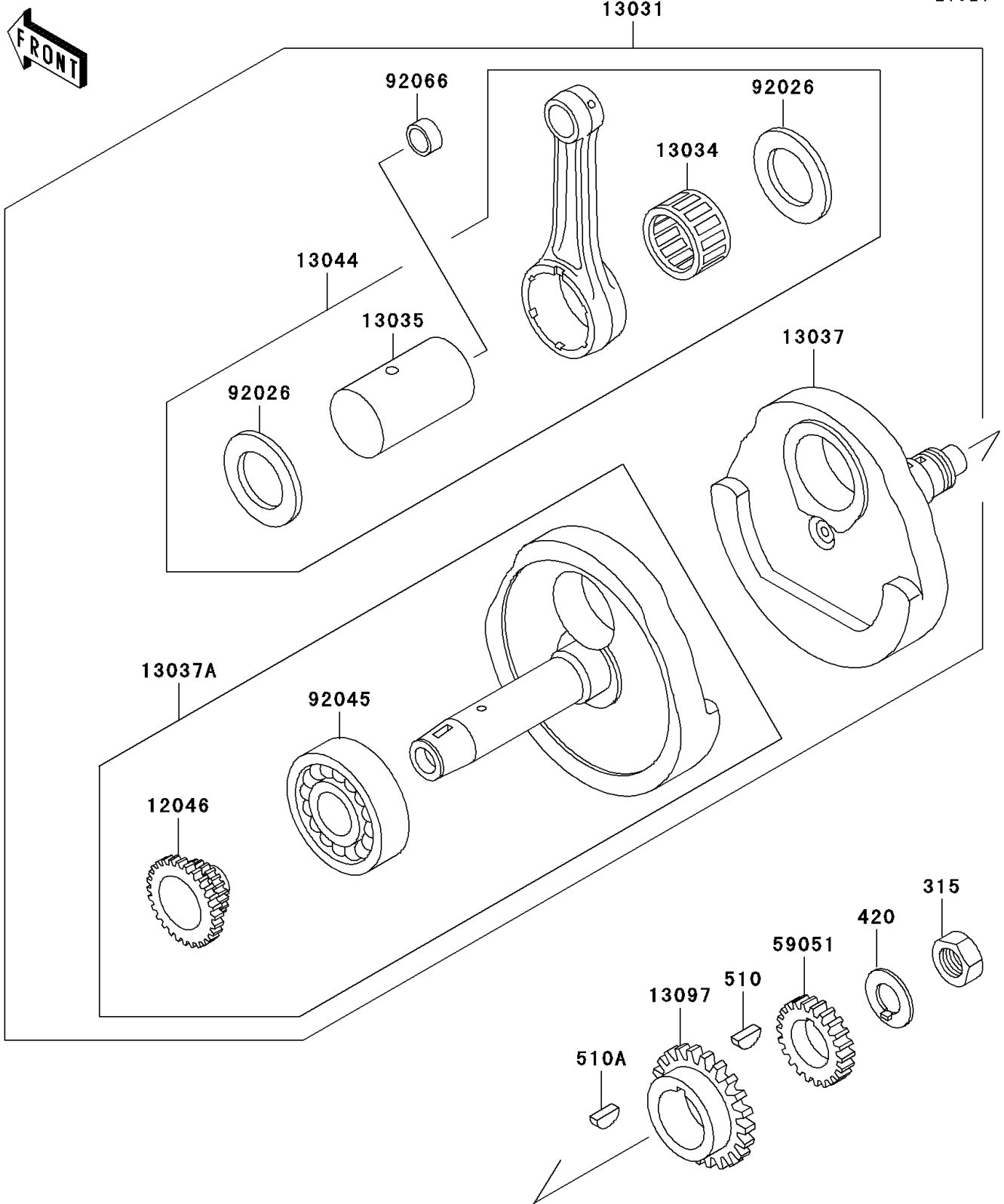

1999 KLR250 PARTS LIST

Crankshaft

ITEM NAME	PART NUMBER	QUANTITY
NUT-HEX-FINE,16MM (Ref # 315)	315B1600	1
WASHER-CLAW,16MM (Ref # 420)	420B1611	1
KEY-WOODRUFF (Ref # 510)	510A3100	1
KEY-WOODRUFF (Ref # 510A)	510A5100	1
SPROCKET,CAM&BALANCER (Ref # 12046)	12046-1064	1
CRANKSHAFT-COMP (Ref # 13031)	13031-1281	1
BEARING-BIG END (Ref # 13034)	13034-1085	1
PIN-CRANK (Ref # 13035)	13035-1069	1
CRANKSHAFT,RH (Ref # 13037)	13037-1226	1
CRANKSHAFT,LH (Ref # 13037A)	13037-5040	1
SET-CONNECTING ROD (Ref # 13044)	13044-5075	1
GEAR-PRIMARY SPUR,23T (Ref # 13097)	13097-1118	1
GEAR-SPUR,OIL PUMP,18T (Ref # 59051)	59051-1122	1
SPACER,32.2X51.5X1.2 (Ref # 92026)	92026-1348	2
BEARING-BALL (Ref # 92045)	92045-1172	1
PLUG (Ref # 92066)	92066-1249	1