

# 2001 KLR250 PARTS DIAGRAM

Water Pump

E3031

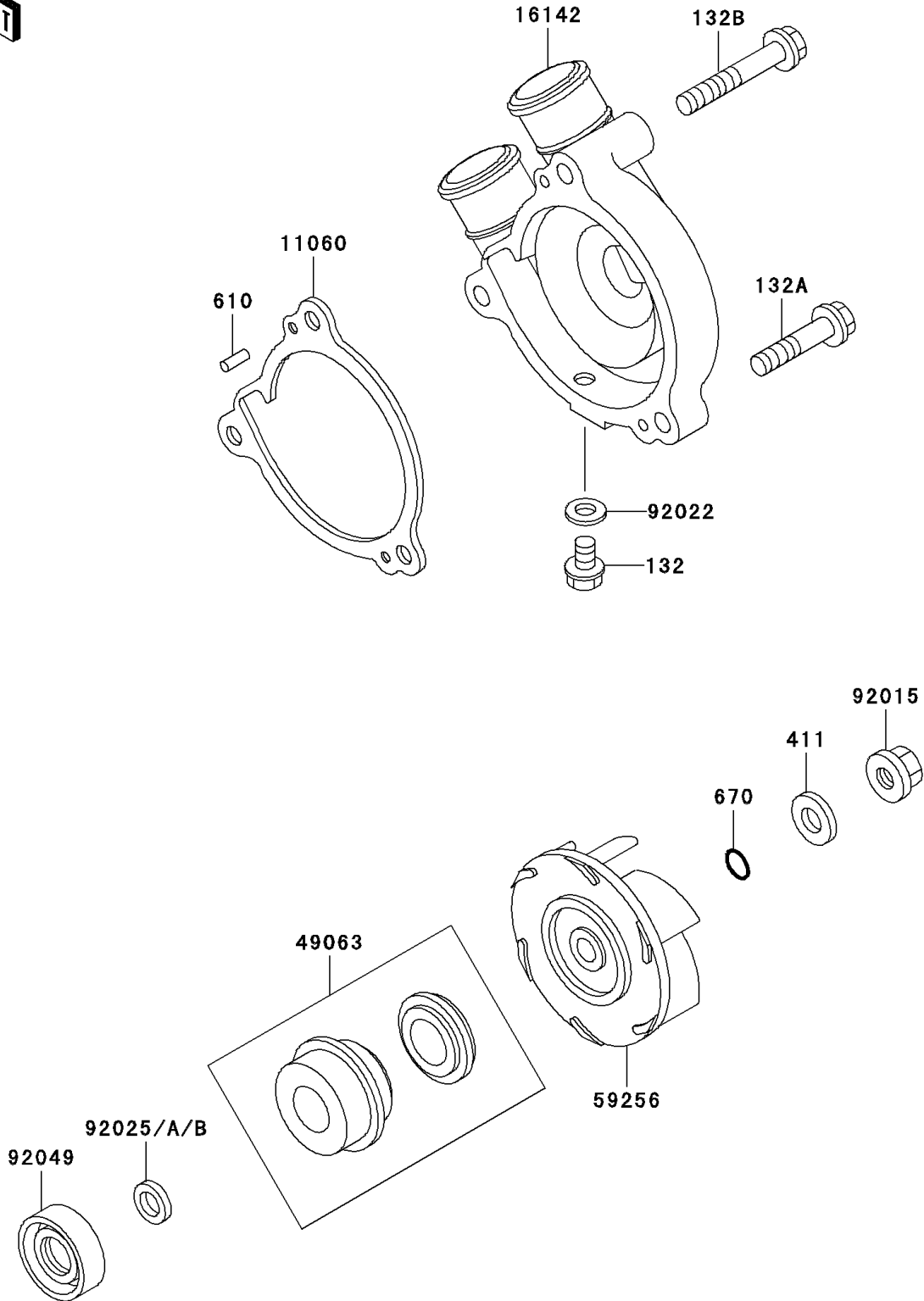

## 2001 KLR250 PARTS LIST

### Water Pump

ITEM NAME	PART NUMBER	QUANTITY
BOLT-FLANGED-SMALL (Ref # 132)	132J0608	1
BOLT-FLANGED-SMALL (Ref # 132A)	132J0630	2
BOLT-FLANGED-SMALL (Ref # 132B)	132J0645	1
WASHER-PLAIN,6MM,BLACK (Ref # 411)	411F0600	1
ROLLER,4X8 (Ref # 610)	610A0408	2
O RING,6MM (Ref # 670)	670B1506	1
GASKET,WATER PUMP (Ref # 11060)	11060-1131	1
COVER-PUMP (Ref # 16142)	16142-1055	1
SEAL-MECHANICAL (Ref # 49063)	49063-1054	1
IMPELLER (Ref # 59256)	59256-1055	1
NUT,FLANGED,6MM (Ref # 92015)	92015-1078	1
WASHER,6.2X11X1 (Ref # 92022)	92022-304	1
SHIM,T=0.8 (Ref # 92025)	92025-1503	AR
SHIM,T=1.4 (Ref # 92025A)	92025-1506	AR
SHIM,T=0.8 (Ref # 92025B)	92025-1507	AR
SEAL-OIL,SC10227 (Ref # 92049)	92049-1157	1