

2001 KLR250 PARTS DIAGRAM

Frame Fittings

F2122

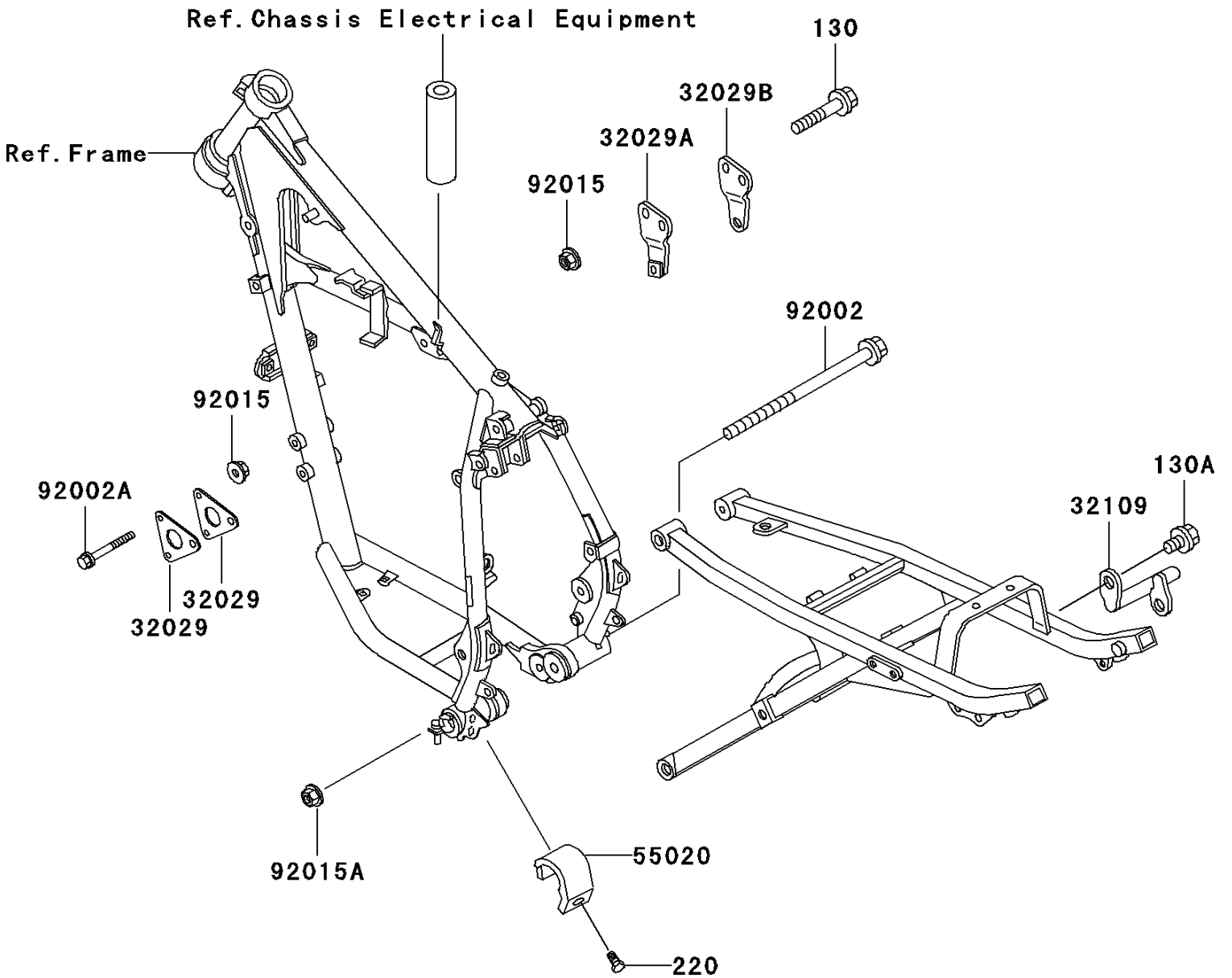

2001 KLR250 PARTS LIST

Frame Fittings

ITEM NAME	PART NUMBER	QUANTITY
BOLT-FLANGED (Ref # 130)	130H0845	3
BOLT-FLANGED (Ref # 130A)	130N0812	2
SCREW-PAN-CROS (Ref # 220)	220B0510	1
BRACKET-ENGINE,FR (Ref # 32029)	32029-1352	2
BRACKET-ENGINE,LH (Ref # 32029A)	32029-1353	1
BRACKET-ENGINE,RH (Ref # 32029B)	32029-1354	1
GRIP-FRAME,RH,SILVER NO.25 (Ref # 32109)	32109-1239-CE	1
GUARD,CHAIN (Ref # 55020)	55020-1174	1
BOLT,FLANGED,12X135 (Ref # 92002)	92002-1347	1
BOLT,FLANGED,8X70 (Ref # 92002A)	92002-1349	3
NUT,FLANGED,8MM (Ref # 92015)	92015-1406	5
NUT,12MM (Ref # 92015A)	92015-1426	1