

1999 KLR250 PARTS DIAGRAM

Brake Pedal

F2260

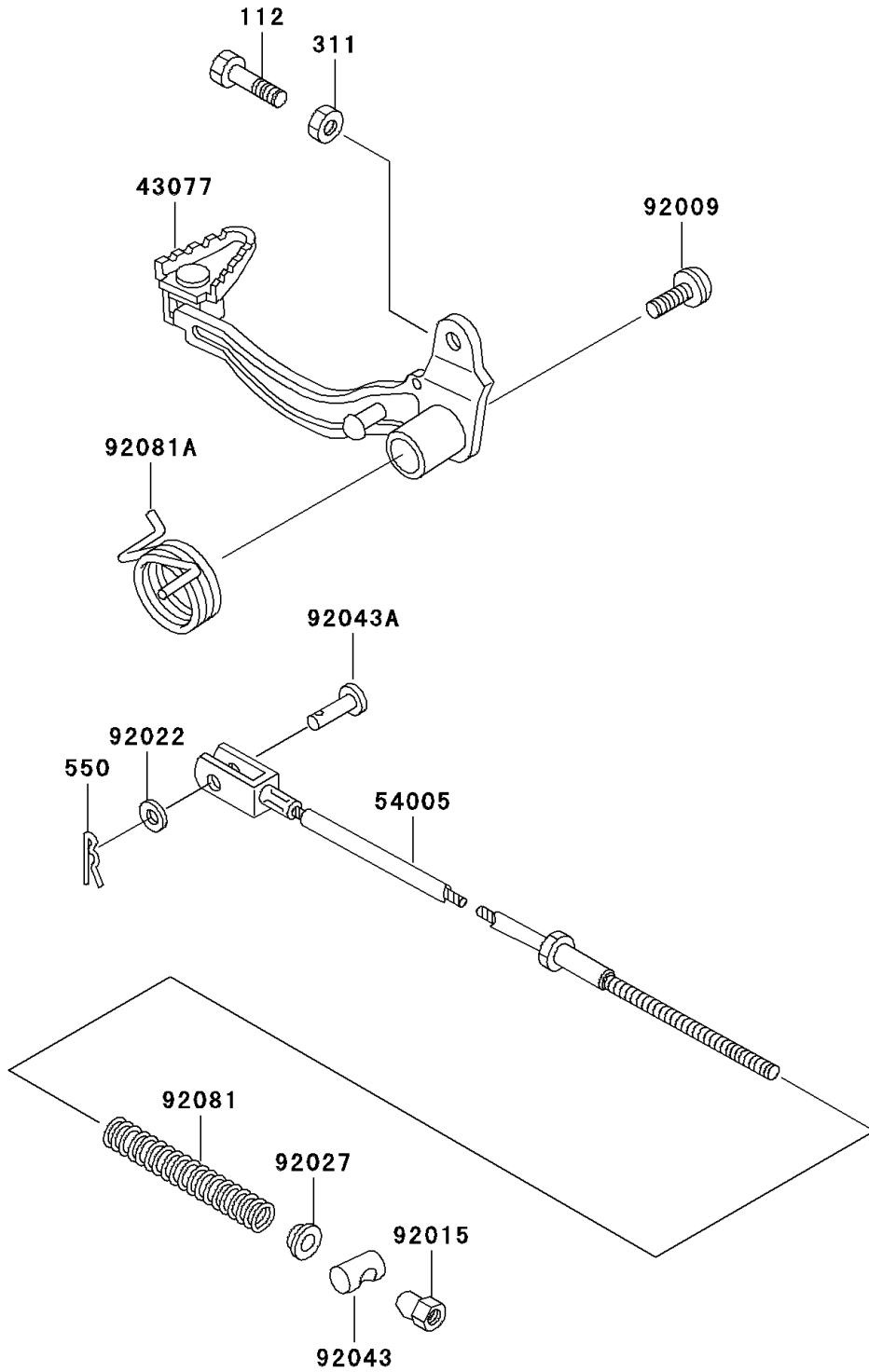

1999 KLR250 PARTS LIST

Brake Pedal

ITEM NAME	PART NUMBER	QUANTITY
BOLT-UPSET,6X25,BLACK (Ref # 112)	112C0625	1
NUT-HEX,6MM (Ref # 311)	311B0600	1
PIN-COTTER,2.0X15 (Ref # 550)	550D2015	1
LEVER-ASSY-BRAKE,PEDAL (Ref # 43077)	43077-1079	1
CABLE-BRAKE,RR (Ref # 54005)	54005-1108	1
SCREW,6X10,WHITE (Ref # 92009)	92009-1286	1
NUT,BRAKE ROD (Ref # 92015)	92015-042	1
WASHER,6.5X11.5X0.8 (Ref # 92022)	92022-1556	1
COLLAR (Ref # 92027)	92027-1794	1
PIN,BRAKE ROD (Ref # 92043)	92043-065	1
PIN,6X14.5 (Ref # 92043A)	92043-125	1
SPRING,REAR BRAKE CABLE (Ref # 92081)	92081-1610	1
SPRING,BRAKE PEDAL RETURN (Ref # 92081A)	92081-1782	1