

2000 KLR250 PARTS DIAGRAM

Seat

F2510

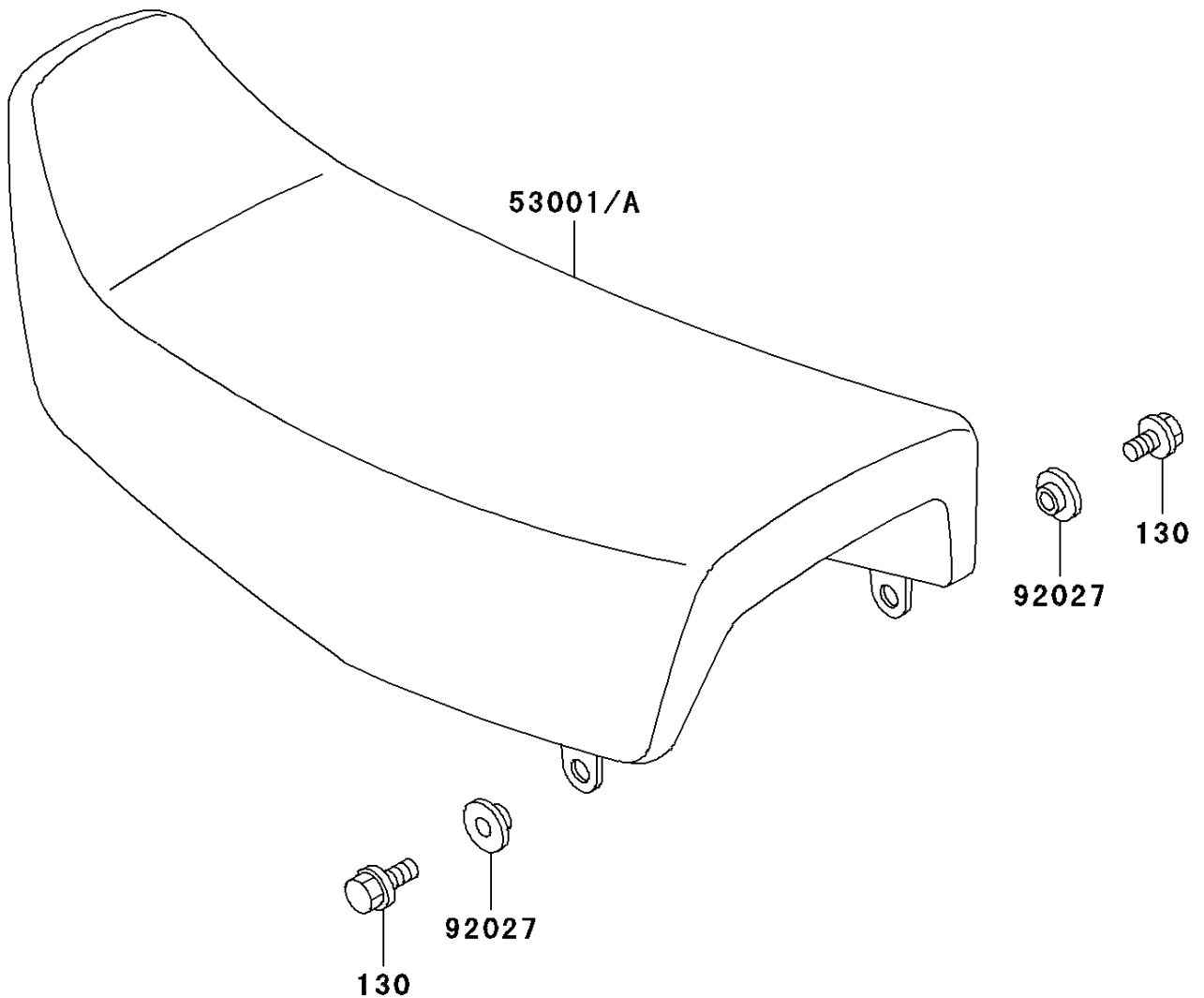

2000 KLR250 PARTS LIST

Seat

ITEM NAME	PART NUMBER	QUANTITY
BOLT-FLANGED,6X12 (Ref # 130)	130B0612	2
SEAT-ASSY,DUAL,S.GRAY (Ref # 53001A)	53001-1731-LJ	1
COLLAR (Ref # 92027)	92027-1794	2