

2005 KLR250 PARTS DIAGRAM

Muffler(s)

E1140

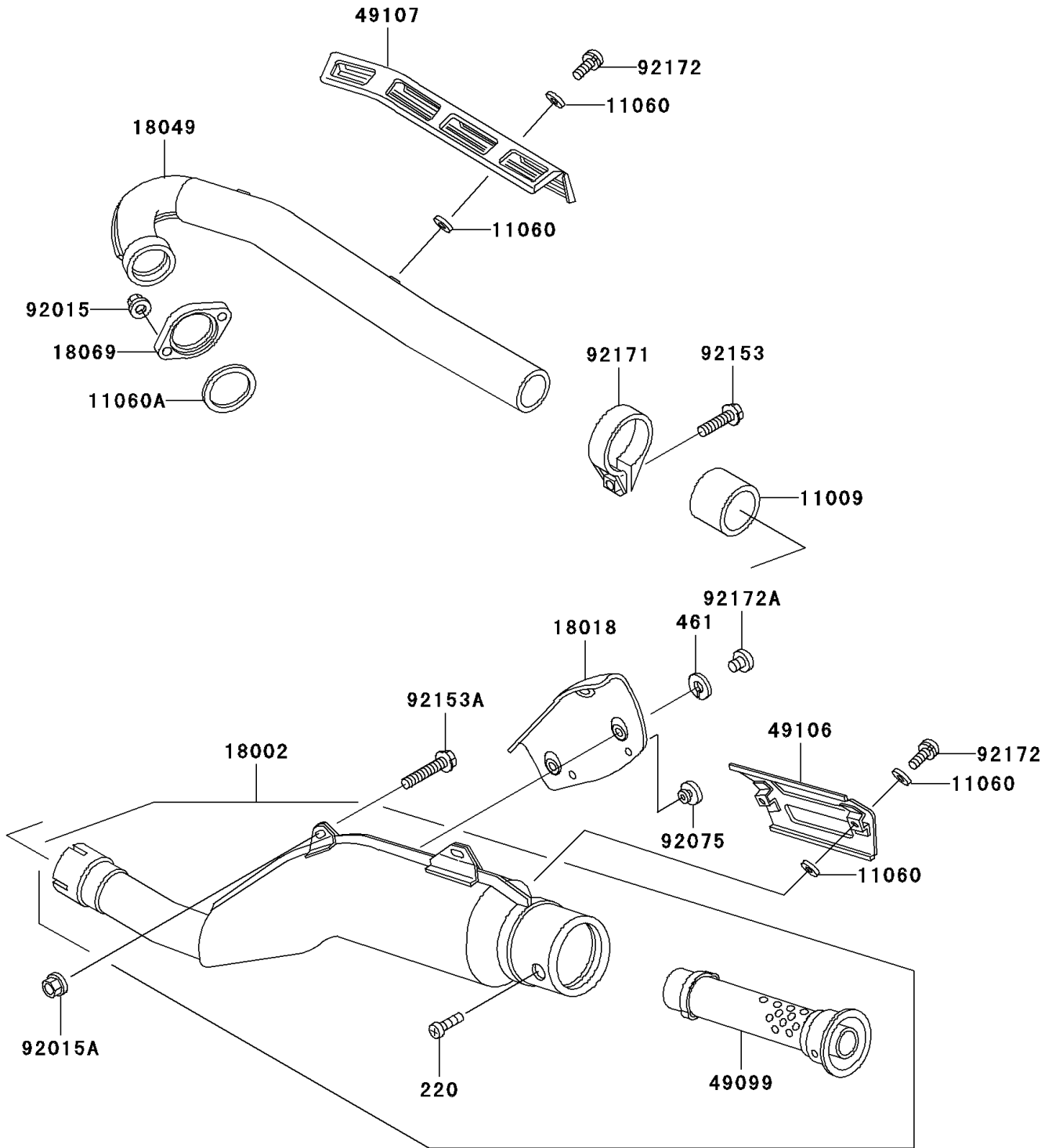

2005 KLR250 PARTS LIST

Muffler(s)

ITEM NAME	PART NUMBER	QUANTITY
SCREW-PAN-CROS,6X10 (Ref # 220)	220B0610	1
WASHER-SPRING,6MM (Ref # 461)	461S0600	3
GASKET,EXHAUST PIPE CONNECTING (Ref # 11009)	11009-1667	1
GASKET,6.2X11.5X1.5 (Ref # 11060)	11060-1109	8
GASKET,EXHAUST PIPE (Ref # 11060A)	11060-1126	1
BODY-COMP-MUFFLER (Ref # 18002)	18002-1740	1
PLATE-HEAT GUARD (Ref # 18018)	18018-1055	1
PIPE-EXHAUST (Ref # 18049)	18049-1461	1
HOLDER-EXHAUST PIPE (Ref # 18069)	18069-1058	1
BAFFLE-PIPE MUFFLER (Ref # 49099)	49099-1219	1
COVER-MUFFLER (Ref # 49106)	49106-1052	1
COVER-EXHAUST PIPE (Ref # 49107)	49107-1057	1
NUT (Ref # 92015)	92015-1331	2
NUT,8MM (Ref # 92015A)	92015-1402	2
DAMPER (Ref # 92075)	92075-005	2
BOLT,8X30 (Ref # 92153)	92153-0504	1
BOLT,8X40 (Ref # 92153A)	92153-0505	2
CLAMP (Ref # 92171)	92171-0172	1
SCREW,6X10 (Ref # 92172)	92172-0097	4
SCREW,6X6.7 (Ref # 92172A)	92172-0104	3