

2003 KLR250 PARTS DIAGRAM

Clutch

E1350

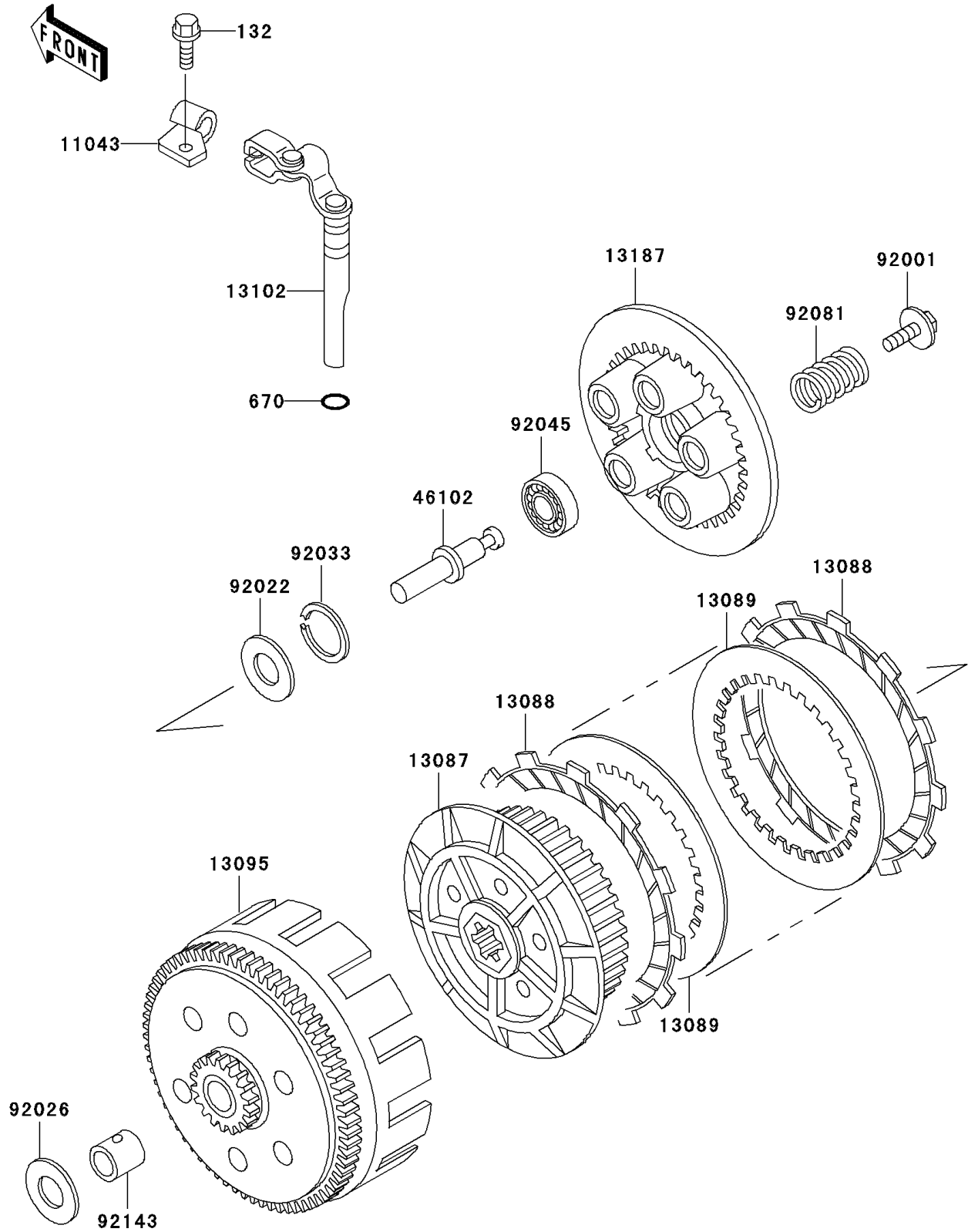

2003 KLR250 PARTS LIST

Clutch

ITEM NAME	PART NUMBER	QUANTITY
BOLT-FLANGED-SMALL (Ref # 132)	132J0612	1
O RING,9MM (Ref # 670)	670B1509	1
BRACKET,CLUTCH CABLE (Ref # 11043)	11043-1931	1
HUB-CLUTCH (Ref # 13087)	13087-1063	1
PLATE-FRICTION (Ref # 13088)	13088-1057	6
PLATE-CLUTCH,T=2.0 (Ref # 13089)	13089-1073	5
HOUSING-COMP-CLUTCH (Ref # 13095)	13095-1126	1
RELEASE-COMP-CLUTCH (Ref # 13102)	13102-1064	1
PLATE-CLUTCH OPERATING (Ref # 13187)	13187-1008	1
ROD,CLUTCH PUSH (Ref # 46102)	46102-1033	1
BOLT,CLUTCH SPRING,6X18 (Ref # 92001)	92001-1576	5
WASHER,20.5X30X1,STEEL (Ref # 92022)	92022-112	1
SPACER,20.1X34X4 (Ref # 92026)	92026-1233	1
RING-SNAP,18MM (Ref # 92033)	92033-029	1
BEARING-BALL,6001C3ML01 (Ref # 92045)	92045-1235	1
SPRING,CLUTCH (Ref # 92081)	92081-083	5
COLLAR (Ref # 92143)	92143-1669	1