

1989 KLR250 PARTS DIAGRAM

Cylinder/Piston(s)

E1120-0080

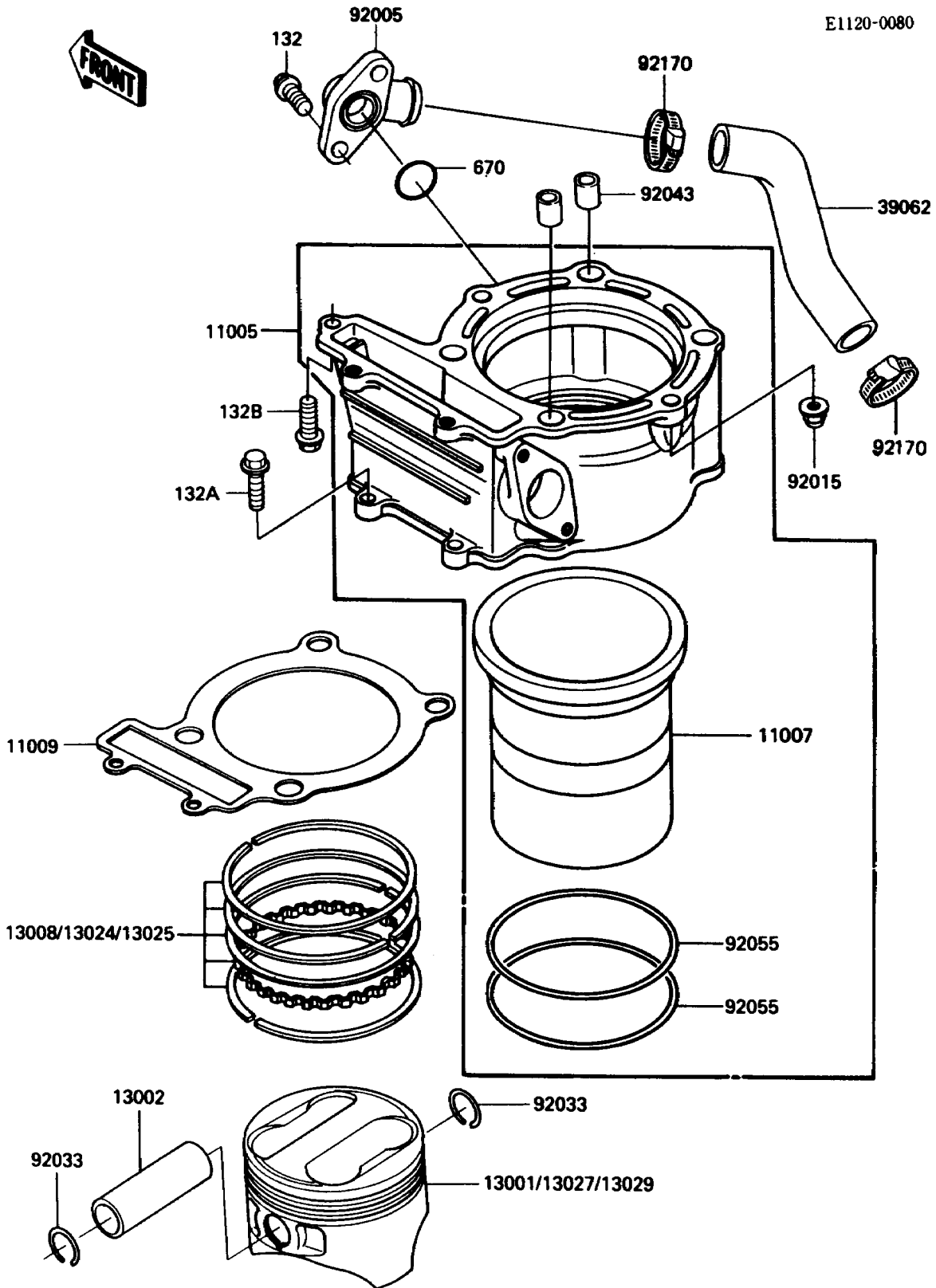

1989 KLR250 PARTS LIST

Cylinder/Piston(s)

ITEM NAME	PART NUMBER	QUANTITY
CYLINDER-ENGINE (Ref # 11005)	11005-1387	1
LINER-CYLINDER (Ref # 11007)	11007-1070	1
GASKET,CYLINDER BASE (Ref # 11009)	11009-1440	1
PISTON-ENGINE,STD (Ref # 13001)	13001-1280	1
PIN-PISTON,12X18X57.2 (Ref # 13002)	13002-1023	1
RING-SET-PISTON,STD (Ref # 13008)	13008-1066	1
RING-SET-PISTON LL,O/S 1.00 (Ref # 13024)	13024-1068	1
RING-SET-PISTON L,O/S 0.50 (Ref # 13025)	13025-1065	1
PISTON-ENGINE LL,O/S 1.00 (Ref # 13027)	13027-1152	1
PISTON-ENGINE L,O/S 0.50 (Ref # 13029)	13029-1175	1
HOSE-COOLING (Ref # 39062)	39062-1082	1
FITTING (Ref # 92005)	92005-1122	1
NUT,CAP,8MM,BLACK (Ref # 92015)	92015-1174	2
RING-SNAP (Ref # 92033)	92033-1182	2
PIN,10.1X12X14 (Ref # 92043)	92043-4009	2
RING-O (Ref # 92055)	92055-1247	2
CLAMP,COOLING HOSE (Ref # 92170)	92170-1033	2
BOLT-FLANGED-SMALL (Ref # 132)	132J0612	2
BOLT-FLANGED-SMALL (Ref # 132A)	132J0620	2
BOLT-FLANGED-SMALL (Ref # 132B)	132J0625	1
O RING,18MM (Ref # 670)	670B2018	1