

1989 KLR250 PARTS DIAGRAM

Generator

E1810-0122

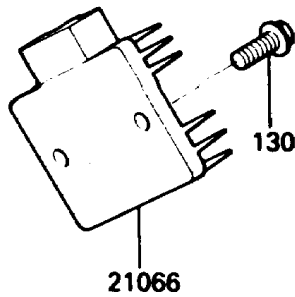
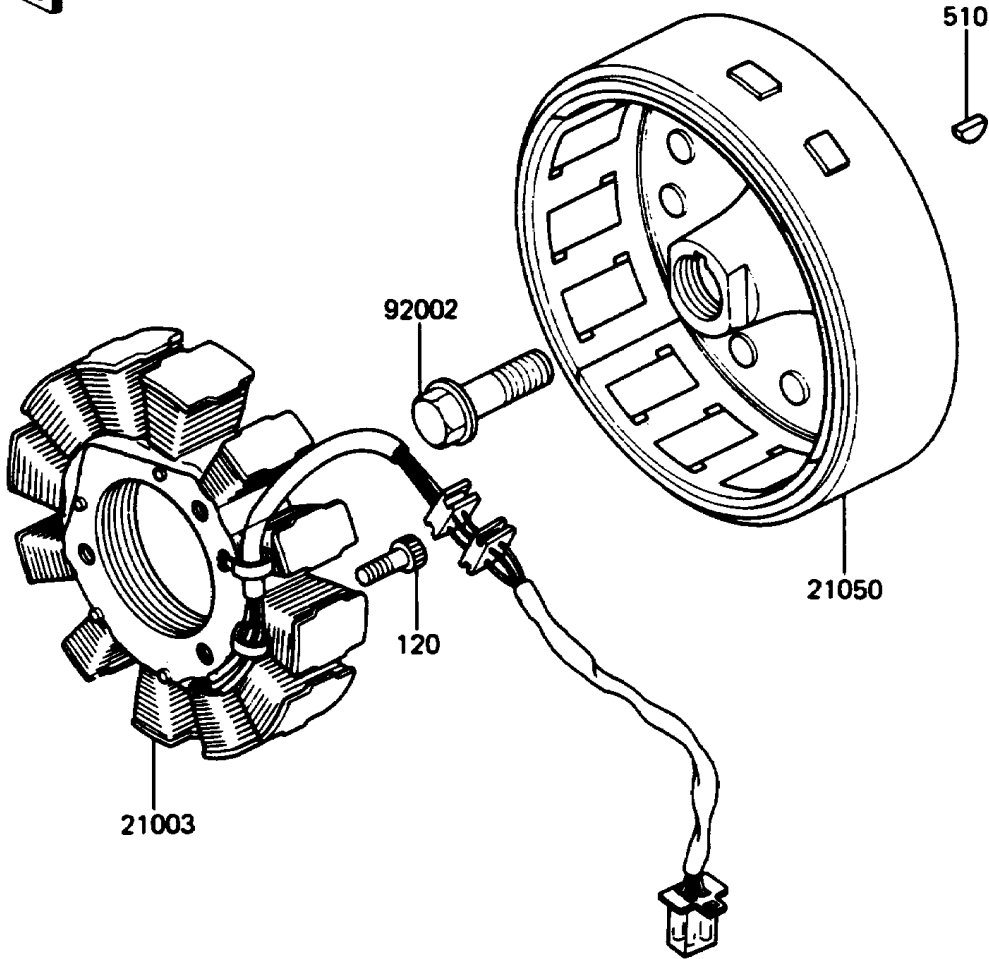

1989 KLR250 PARTS LIST

Generator

ITEM NAME	PART NUMBER	QUANTITY
STATOR (Ref # 21003)	21003-1121	1
FLYWHEEL (Ref # 21050)	21050-1109	1
REGULATOR-VOLTAGE (Ref # 21066)	21066-1052	1
BOLT,FLANGED,12X40 (Ref # 92002)	92002-1693	1
BOLT-SOCKET,6X30 (Ref # 120)	120P0630	3
BOLT-FLANGED,6X16 (Ref # 130)	130G0616	1
KEY-WOODRUFF (Ref # 510)	510A3300	1