

1988 KLR250 PARTS DIAGRAM

Frame

F2120-0304

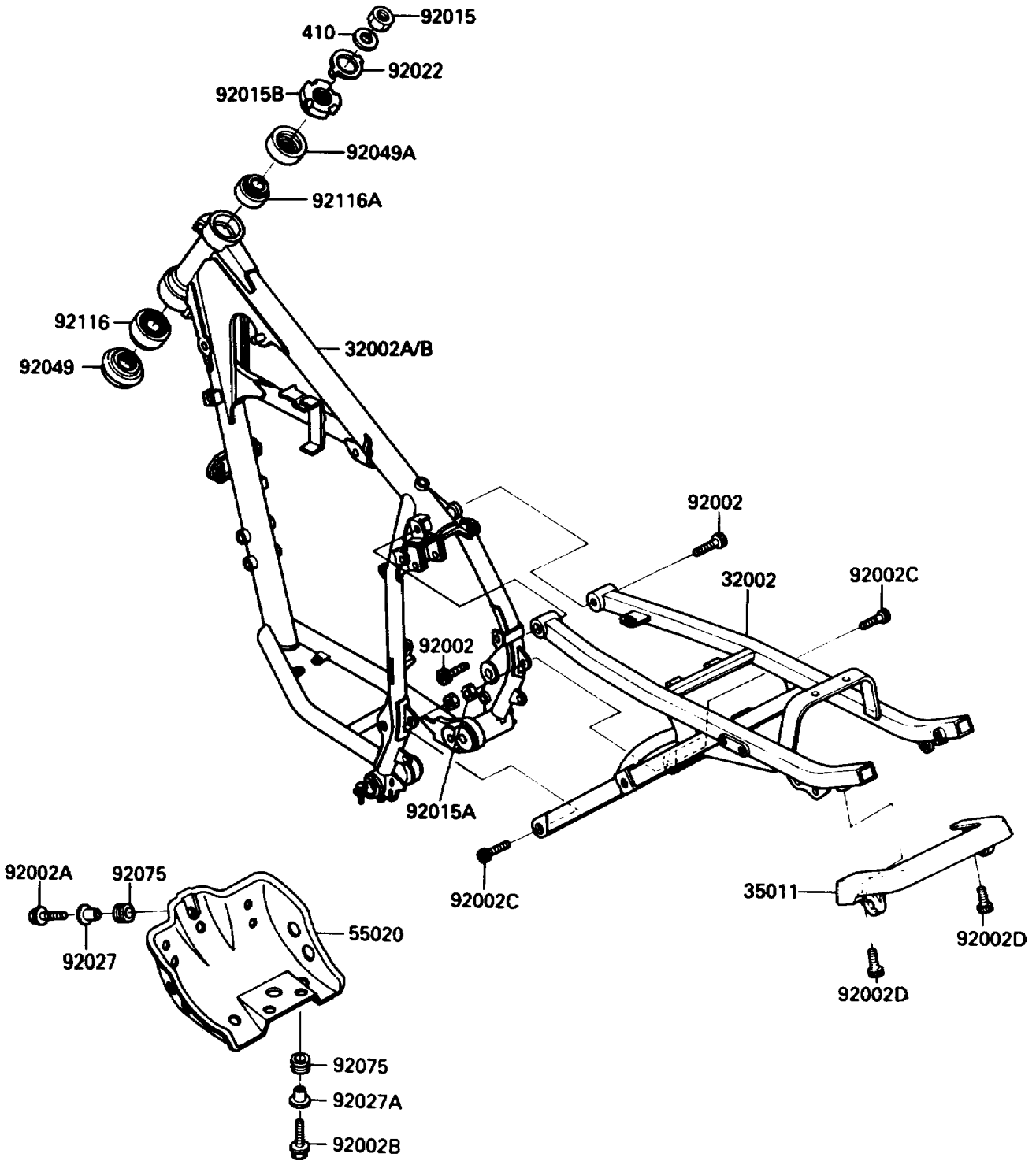

1988 KLR250 PARTS LIST

Frame

ITEM NAME	PART NUMBER	QUANTITY
FRAME-COMP,AL,RR (Ref # 32002)	32002-1762	1
FRAME-COMP,FR (Ref # 32002A)	32002-1925	1
FRAME-COMP,FR (Ref # 32002B)	32002-1926	1
STAY,FRAME,RR (Ref # 35011)	35011-1236	1
GUARD,ENGINE (Ref # 55020)	55020-1168	1
BOLT,SOCKET,8X40 (Ref # 92002)	92002-1181	2
BOLT,FLANGED,8X20 (Ref # 92002A)	92002-1417	1
BOLT,6X20 (Ref # 92002B)	92002-1418	2
BOLT,SOCKET,8X25 (Ref # 92002C)	92002-1442	2
BOLT,SOCKET,8X10 (Ref # 92002D)	92002-1443	2
NUT,18MM (Ref # 92015)	92015-1404	1
NUT,FLANGED,8MM (Ref # 92015A)	92015-1406	2
NUT,25MM,T=12 (Ref # 92015B)	92015-1546	1
WASHER,CLAW,18.5X30X2.3 (Ref # 92022)	92022-1555	1
COLLAR,L=12 (Ref # 92027)	92027-1842	1
COLLAR,L=13.1 (Ref # 92027A)	92027-251	2
SEAL-OIL,XMHE36X52X4J (Ref # 92049)	92049-1162	1
SEAL-OIL,STEERING STEM (Ref # 92049A)	92049-1214	1
DAMPER (Ref # 92075)	92075-209	3
BEARING-ROLLER,HR320/28XJ (Ref # 92116)	92116-1009	1
BEARING-ROLLER,HICAP 32005JR (Ref # 92116A)	92116-1052	1
W-PLAIN-S (Ref # 410)	410F1800	1