

# 1989 KLR250 PARTS DIAGRAM

Labels

F2860-0576

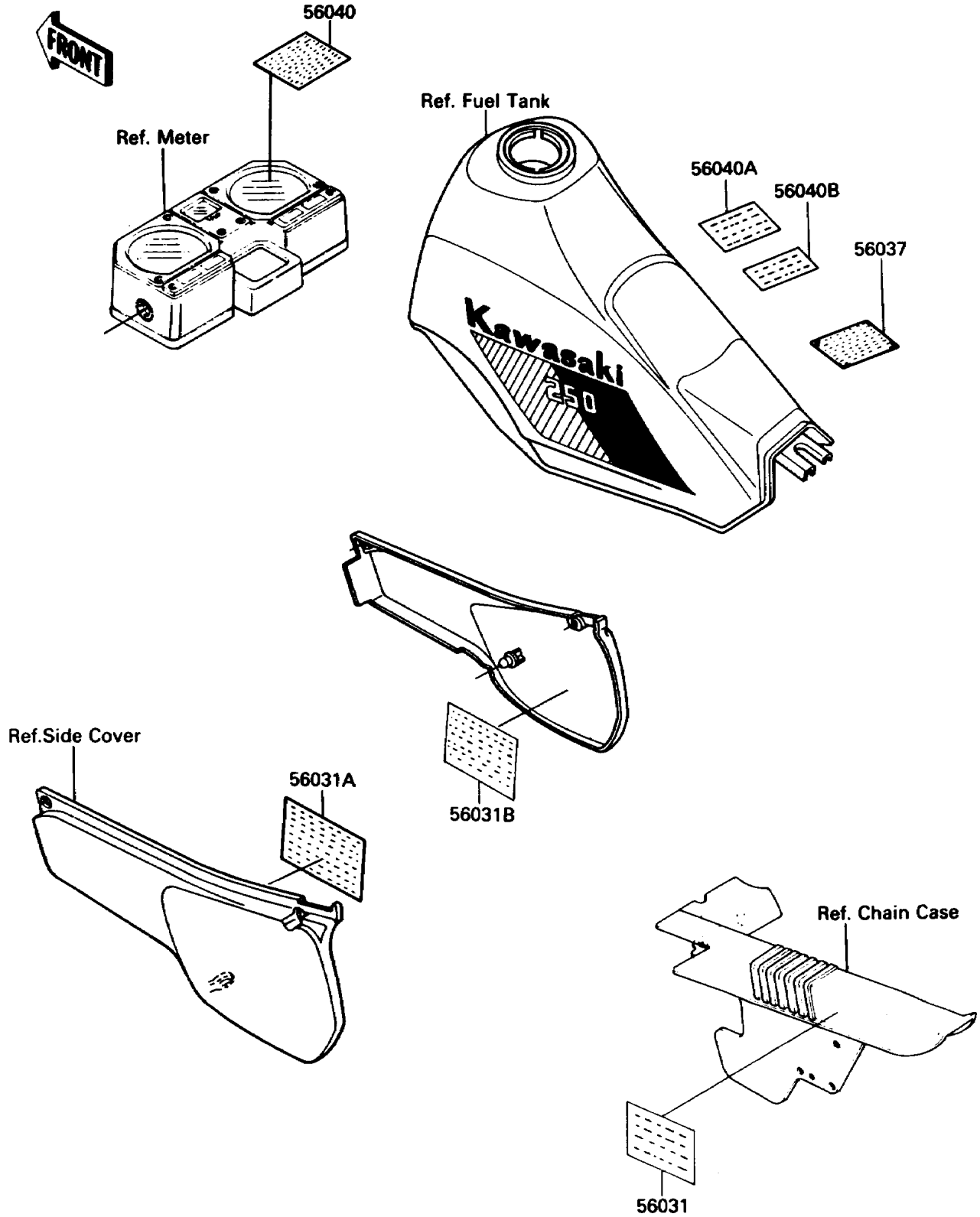

# 1989 KLR250 PARTS LIST

## Labels

ITEM NAME	PART NUMBER	QUANTITY
LABEL-MANUAL,CHAIN (Ref # 56031)	56031-1369	1
LABEL-MANUAL,BATTERY VENT (Ref # 56031A)	56031-1371	1
LABEL-MANUAL,OIL&OIL FILTER (Ref # 56031B)	56031-1470	1
LABEL-SPECIFICATION,TIRE&LOAD (Ref # 56037)	56037-1295	1
LABEL-WARNING,BREAK IN CAUTION (Ref # 56040)	56040-1007	1
LABEL-WARNING,BREAK IN CAUTION (Ref # 56040A)	56040-1008	1
LABEL-WARNING,EVAPO (Ref # 56040B)	56040-1121	1