

1990 KLR250 PARTS DIAGRAM

Gear Change Mechanism

E1370

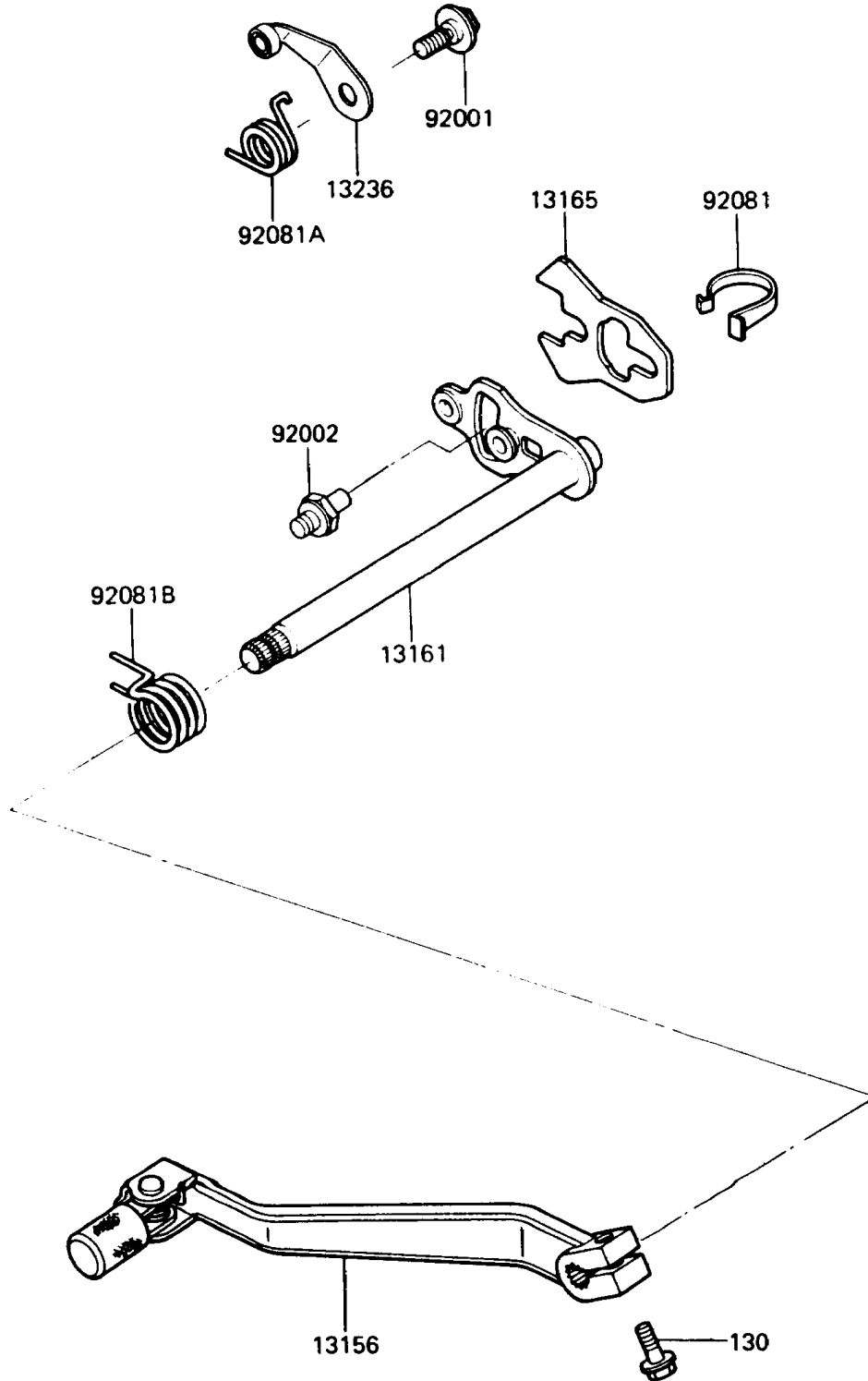

1990 KLR250 PARTS LIST

Gear Change Mechanism

ITEM NAME	PART NUMBER	QUANTITY
LEVER-CHANGE,PEDAL (Ref # 13156)	13156-1178	1
LEVER-COMP-CHANGE SHAFT (Ref # 13161)	13161-1115	1
PAWL,CHANGE LEVER (Ref # 13165)	13165-1034	1
LEVER-COMP,CHANGE DRUM (Ref # 13236)	13236-1117	1
BOLT,GEAR CHANGE LEVER (Ref # 92001)	92001-1715	1
BOLT,RETURN SPRING (Ref # 92002)	92002-1355	1
SPRING,CHANGE LEVER (Ref # 92081)	92081-1493	1
SPRING (Ref # 92081A)	92081-1496	1
SPRING,CHANGE PEDAL RETURN (Ref # 92081B)	92081-1750	1
BOLT-FLANGED,6X20,BLACK (Ref # 130)	130S0620	1