

2001 Super Sherpa PARTS DIAGRAM

Crankshaft

E1321

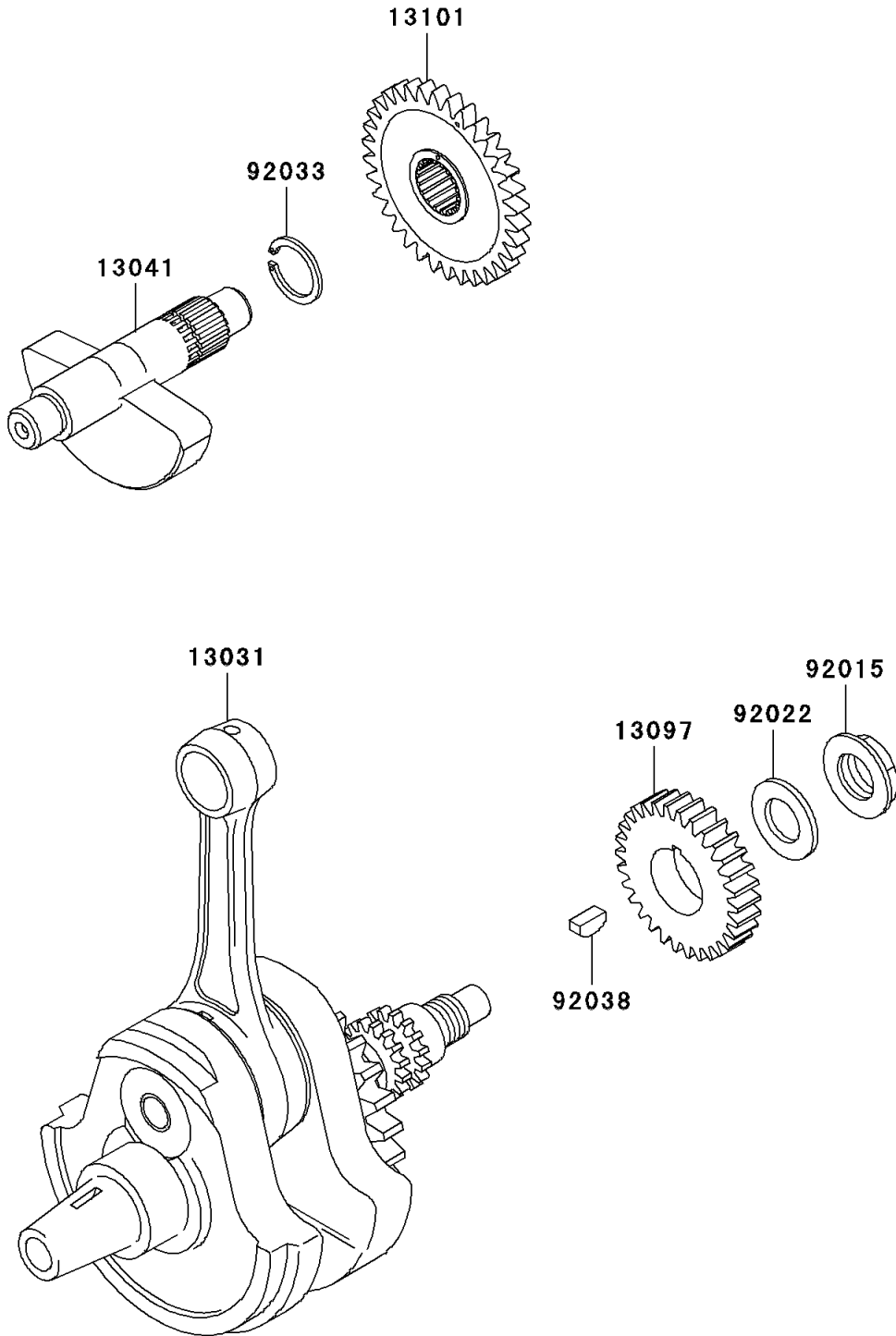

2001 Super Sherpa PARTS LIST

Crankshaft

ITEM NAME	PART NUMBER	QUANTITY
CRANKSHAFT-COMP (Ref # 13031)	13031-1424	1
BALANCER (Ref # 13041)	13041-1120	1
GEAR-PRIMARY SPUR,30T (Ref # 13097)	13097-1385	1
GEAR-ASSY,BALANCER (Ref # 13101)	13101-1253	1
NUT,16MM (Ref # 92015)	92015-1581	1
WASHER,16.3X29X1.75 (Ref # 92022)	92022-1356	1
RING-SNAP,18MM (Ref # 92033)	92033-029	1
KEY (Ref # 92038)	92038-1057	1