

2003 Super Sherpa PARTS DIAGRAM

Frame

F2120

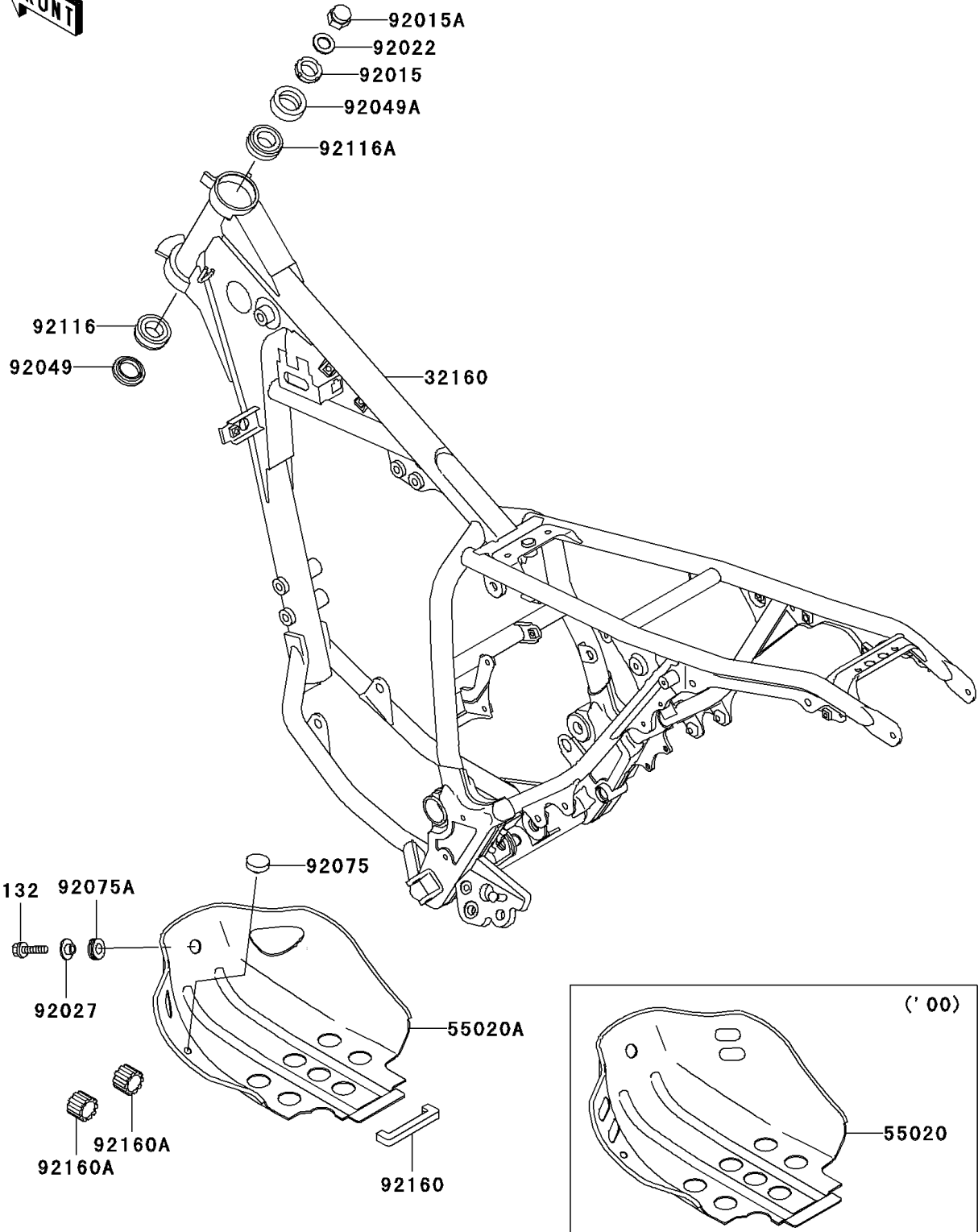

2003 Super Sherpa PARTS LIST

Frame

ITEM NAME	PART NUMBER	QUANTITY
BOLT-FLANGED-SMALL (Ref # 132)	132V0620	1
FRAME-COMP,C.GRAY (Ref # 32160)	32160-1600-EZ	1
GUARD,ENGINE (Ref # 55020A)	55020-1734	1
NUT,25MM,T=12 (Ref # 92015)	92015-1546	1
NUT,STEERING STEM,22MM (Ref # 92015A)	92015-1867	1
WASHER,STEERING STEM (Ref # 92022)	92022-1873	1
COLLAR,L=13.1 (Ref # 92027)	92027-251	1
SEAL-OIL,XMHE36X52X4J (Ref # 92049)	92049-1162	1
SEAL-OIL,STEERING STEM (Ref # 92049A)	92049-1214	1
DAMPER (Ref # 92075)	92075-005	1
DAMPER (Ref # 92075A)	92075-1690	1
BEARING-ROLLER,HR320/28XJ (Ref # 92116)	92116-1009	1
BEARING-ROLLER,HICAP 32005JR (Ref # 92116A)	92116-1052	1
DAMPER (Ref # 92160)	92160-1835	1
DAMPER (Ref # 92160A)	92160-1884	2