

2003 Super Sherpa PARTS DIAGRAM

Fenders

F2170

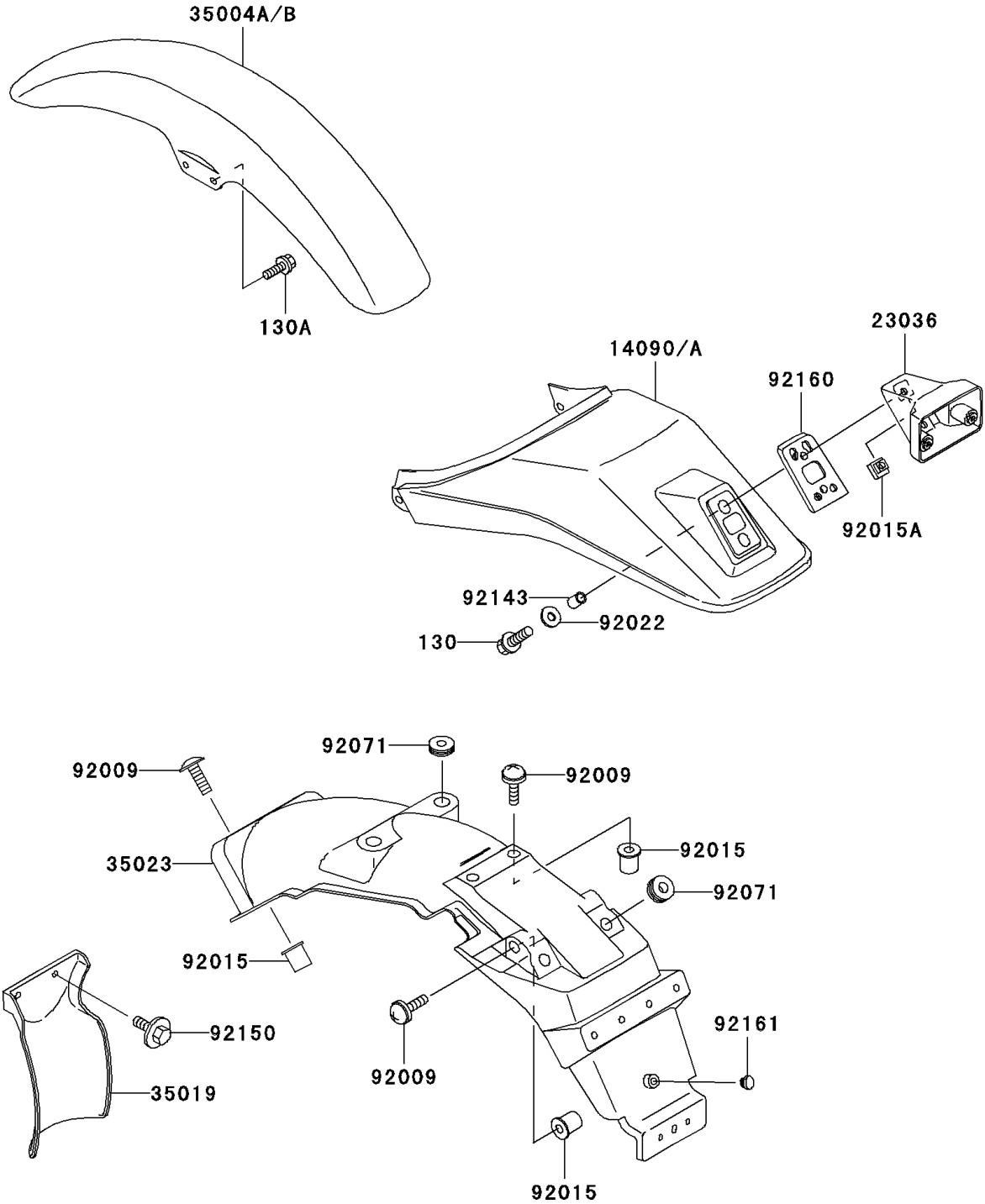

2003 Super Sherpa PARTS LIST

Fenders

ITEM NAME	PART NUMBER	QUANTITY
BOLT-FLANGED (Ref # 130)	130G0520	2
BOLT-FLANGED,6X16 (Ref # 130A)	130G0616	4
COVER,SEAT,O.GREEN (Ref # 14090A)	14090-1796-68	1
BRACKET-TAIL LAMP (Ref # 23036)	23036-1146	1
FENDER-FRONT,LOW TYPE,O.GREEN (Ref # 35004B)	35004-1365-68	1
FLAP,RR FENDER,FR (Ref # 35019)	35019-1345	1
FENDER-REAR (Ref # 35023)	35023-1530	1
SCREW,6X18 (Ref # 92009)	92009-1663	6
NUT (Ref # 92015)	92015-1700	6
NUT,5MM (Ref # 92015A)	92015-1798	2
WASHER,5.2X16X1.2 (Ref # 92022)	92022-263	2
GROMMET (Ref # 92071)	92071-056	4
COLLAR,5.6X8X9.3 (Ref # 92143)	92143-1984	2
BOLT,6X14 (Ref # 92150)	92150-1133	2
DAMPER,TAIL LAMP BRACKET (Ref # 92160)	92160-1826	1
DAMPER (Ref # 92161)	92161-1084	1