

2003 Super Sherpa PARTS DIAGRAM

Rear Hub

F2240

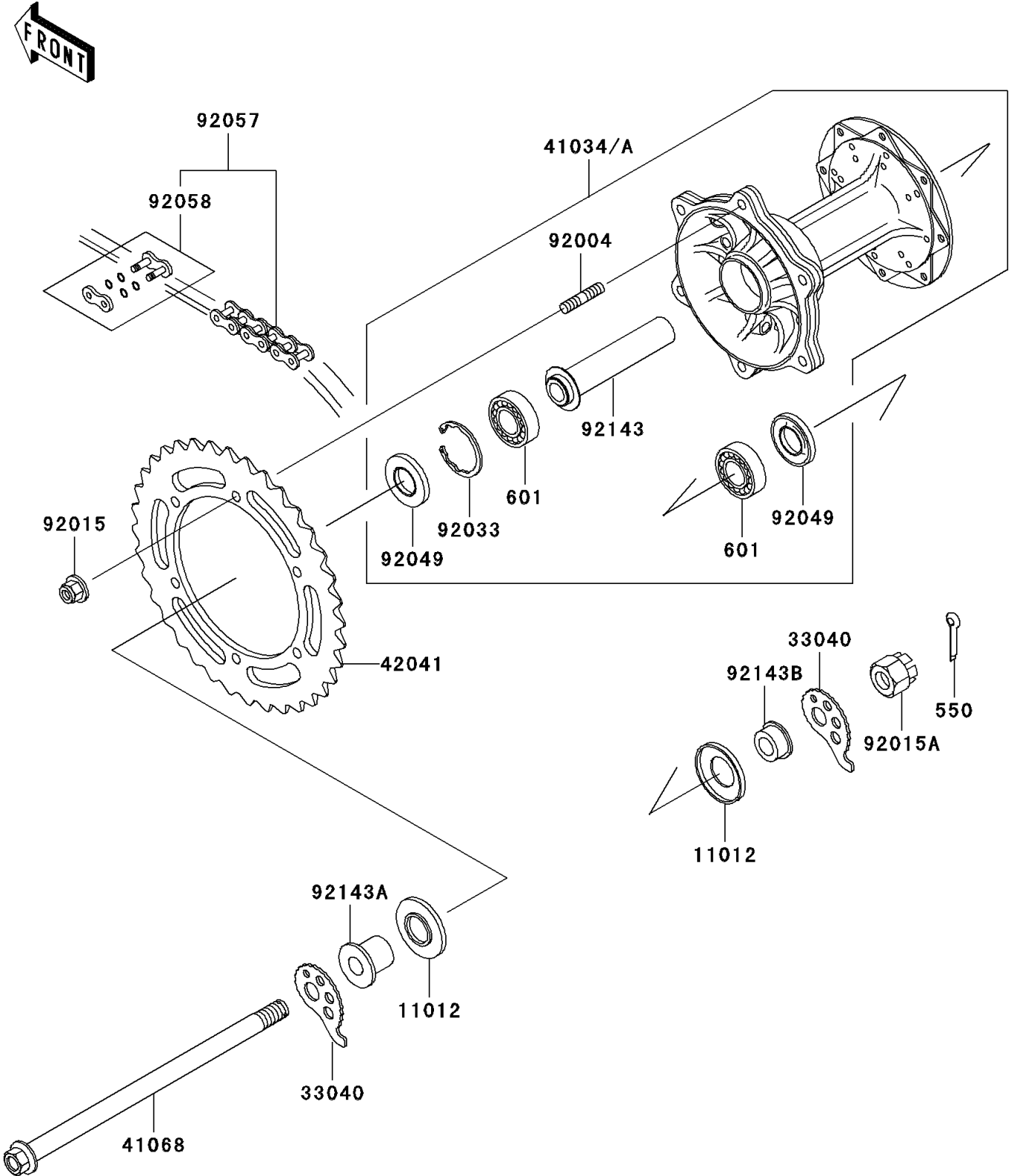

2003 Super Sherpa PARTS LIST

Rear Hub

ITEM NAME	PART NUMBER	QUANTITY
PIN-COTTER,3.0X25 (Ref # 550)	550D3025	1
BEARING-BALL,#6302UG (Ref # 601)	601B6302UG	2
CAP,AXLE (Ref # 11012)	11012-1581	2
ADJUSTER-CHAIN (Ref # 33040)	33040-1163	2
DRUM-ASSY,REAR BRAKE (Ref # 41034A)	41034-1306	1
AXLE,RR (Ref # 41068)	41068-1393	1
SPROCKET-HUB,43T (Ref # 42041)	42041-1488	1
STUD,8X17 (Ref # 92004)	92004-1239	6
NUT,8MM (Ref # 92015)	92015-1432	6
NUT,CASTLE,14MM (Ref # 92015A)	92015-1765	1
RING-SNAP,42MM (Ref # 92033)	92033-1041	1
SEAL-OIL,MHSA25 42 6 (Ref # 92049)	92049-1314	2
CHAIN,DRIVE,EK520LV-OX102L (Ref # 92057)	92057-0017	1
JOINT-CHAIN,DRIVE (Ref # 92058)	92058-1100	1
COLLAR,L=115 (Ref # 92143)	92143-1020	1
COLLAR,RR AXLE,LH,L=28 (Ref # 92143A)	92143-1924	1
COLLAR,RR AXLE,RH,L=13 (Ref # 92143B)	92143-1925	1