

2002 Super Sherpa PARTS DIAGRAM

Owner's Tools

56007

F2810

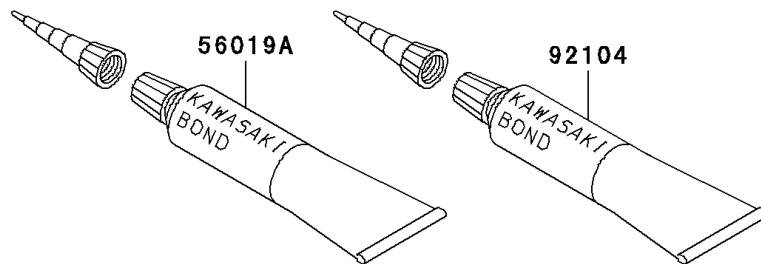
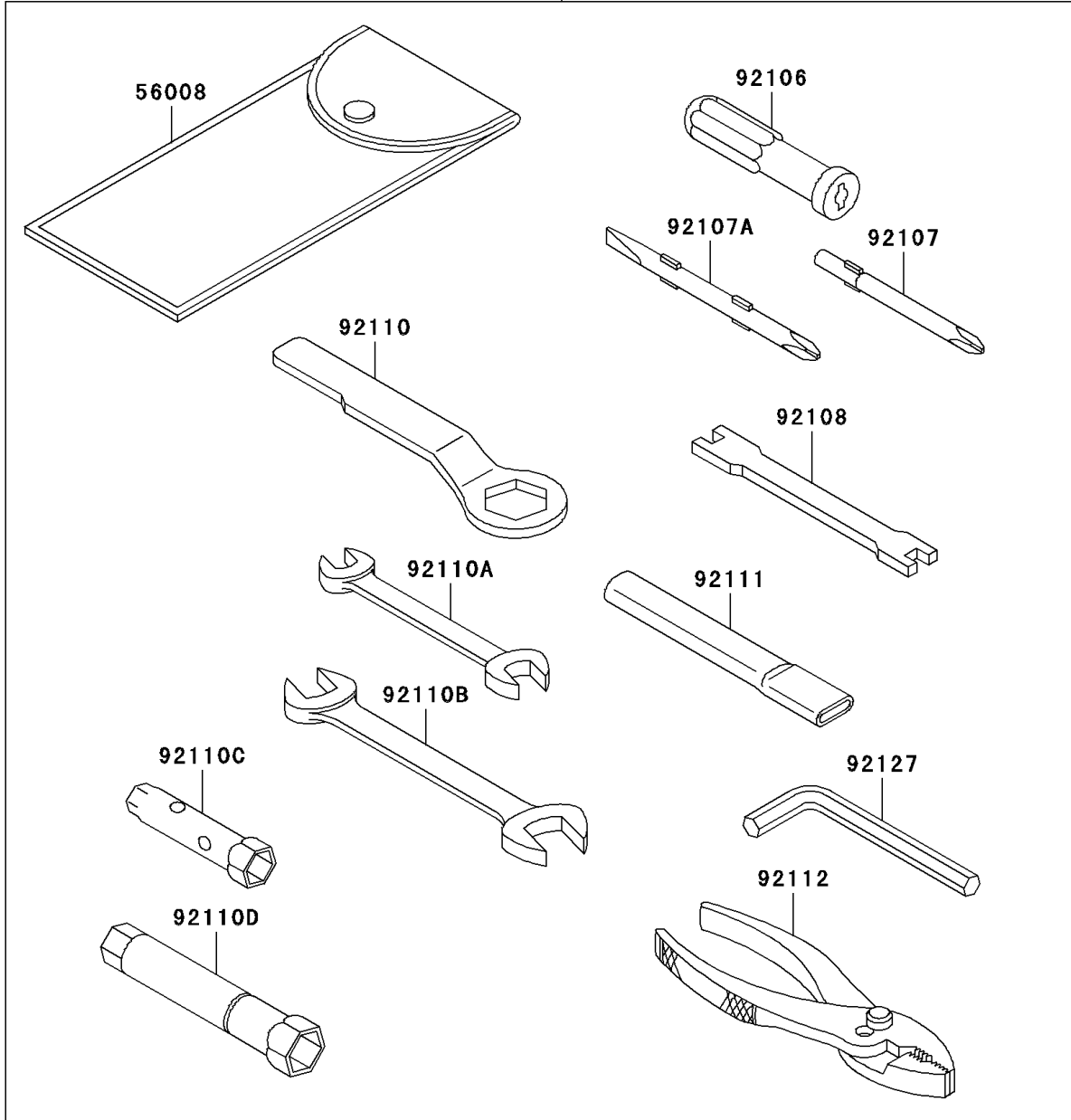

2002 Super Sherpa PARTS LIST

Owner's Tools

ITEM NAME	PART NUMBER	QUANTITY
TOOL-KIT (Ref # 56007)	56007-1408	1
BAG,TOOL (Ref # 56008)	56008-1075	1
THREE BOND TB1211,HT/RS,WHITE (Ref # 56019A)	56019-120	1
GASKET-LIQUID,TUBE,100G,BLACK (Ref # 92104)	92104-1003	1
GRIP-SCREW DRIVER (Ref # 92106)	92106-1001	1
TOOL-DRIVER,#3PHILLIPS (Ref # 92107)	92107-005	1
TOOL-DRIVER,#2PHILLIPS&SLOT (Ref # 92107A)	92107-1051	1
TOOL-WRENCH,SPOKE (Ref # 92108)	92108-011	1
TOOL-WRENCH,BOX END,22MM (Ref # 92110)	92110-1148	1
TOOL-WRENCH,OPEN END,10X12 (Ref # 92110A)	92110-1152	1
TOOL-WRENCH,OPEN END,14X17 (Ref # 92110B)	92110-1153	1
TOOL-WRENCH,BOX,8&10MM (Ref # 92110C)	92110-1160	1
TOOL-WRENCH,BOX,16MM (Ref # 92110D)	92110-1172	1
TOOL-BAR,BOX END WRENCH (Ref # 92111)	92111-1051	1
TOOL-PLIERS (Ref # 92112)	92112-1001	1
TOOL-WRENCH,ALLEN,6MM (Ref # 92127)	92127-003	1