

2001 Super Sherpa PARTS DIAGRAM

Labels

F2860

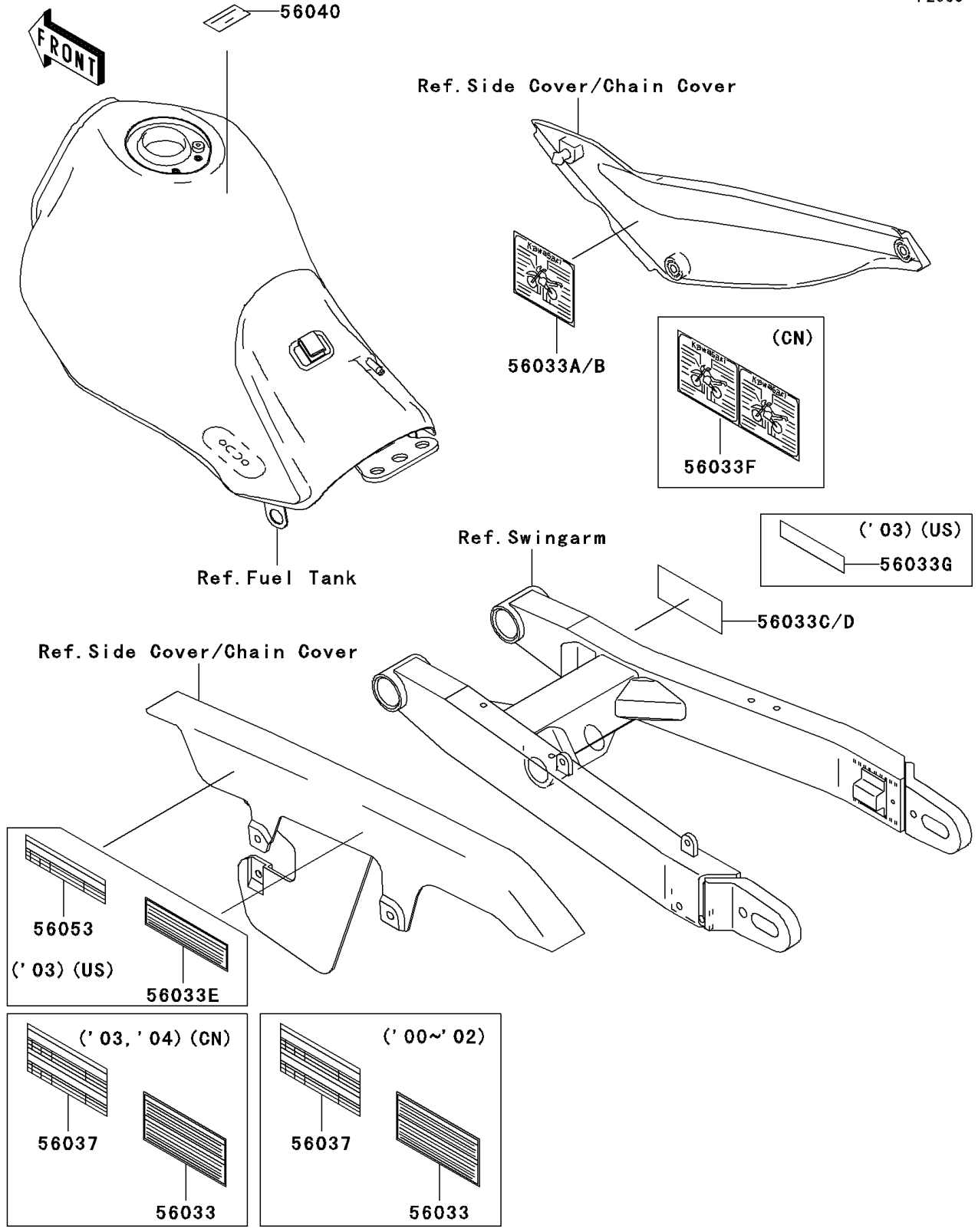

2001 Super Sherpa PARTS LIST

Labels

ITEM NAME	PART NUMBER	QUANTITY
LABEL-MANUAL,CHAIN (Ref # 56033)	56033-1087	1
LABEL-MANUAL,DAILY SAFETY (Ref # 56033A)	56033-1088	1
LABEL-MANUAL,OIL&OIL FILTER (Ref # 56033C)	56033-1229	1
LABEL-SPECIFICATION,TIRE&LOAD (Ref # 56037)	56037-1814	1
LABEL-MANUAL,DAILY SAFETY (Ref # 56033B)	56033-1173	1
LABEL-WARNING,BREAK IN CAUTION (Ref # 56040)	56040-1008	1