

1990 KLR650 PARTS DIAGRAM

Camshaft/Tensioner

E1230-0063

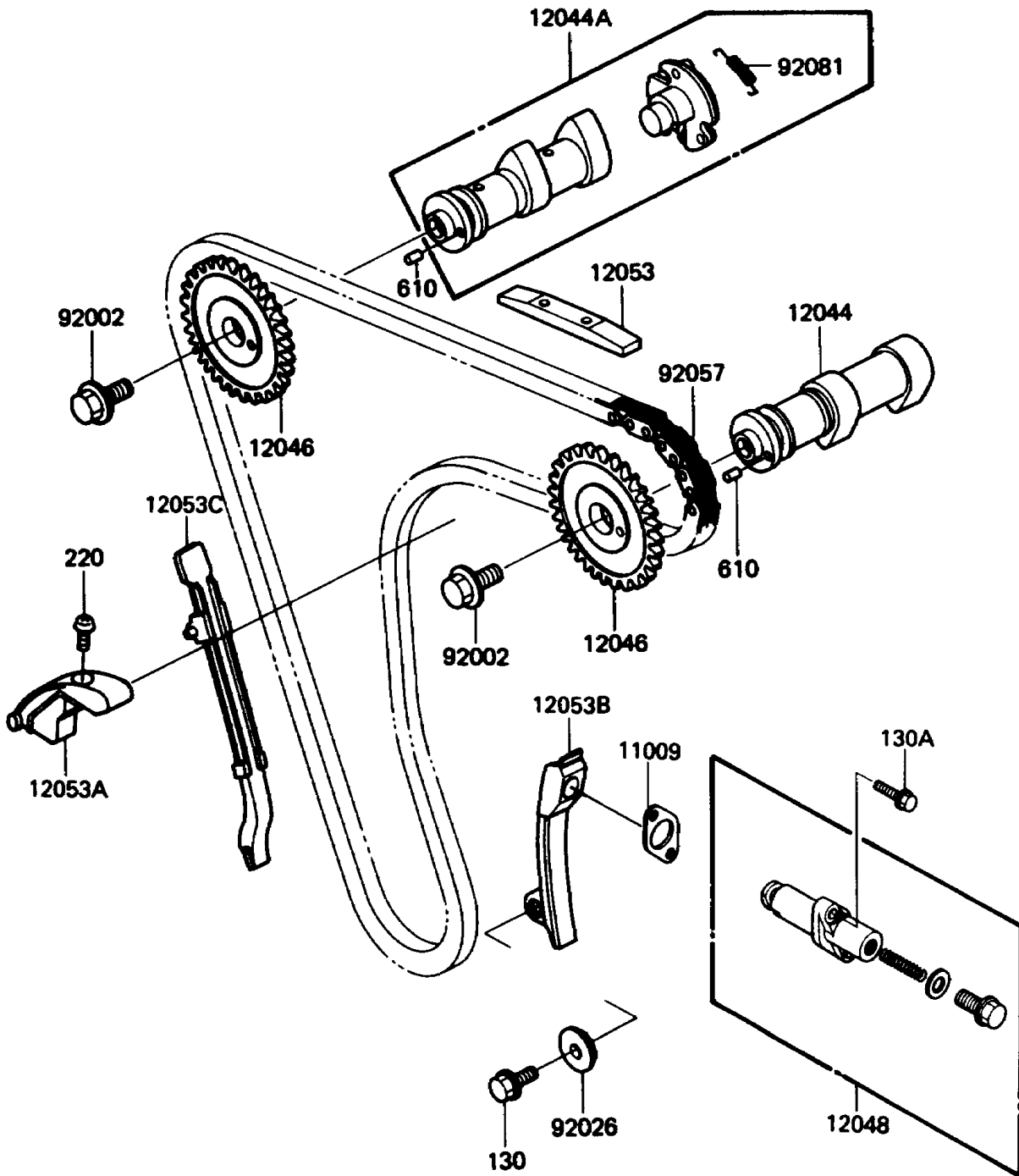

1990 KLR650 PARTS LIST

Camshaft/Tensioner

ITEM NAME	PART NUMBER	QUANTITY
GASKET,TENSIONER (Ref # 11009)	11009-1858	1
CAMSHAFT-VALVE,INTAKE (Ref # 12044)	12044-1114	1
CAMSHAFT-VALVE,EXHAUST (Ref # 12044A)	12044-1197	1
SPROCKET,CAMSHAFT,48T (Ref # 12046)	12046-1062	2
TENSIONER-ASSY (Ref # 12048)	12048-1086	1
GUIDE-CHAIN,UPP (Ref # 12053)	12053-1107	1
GUIDE-CHAIN,LWR (Ref # 12053A)	12053-1134	1
GUIDE-CHAIN,RR (Ref # 12053B)	12053-1222	1
GUIDE-CHAIN,FR (Ref # 12053C)	12053-1223	1
BOLT,10X23 (Ref # 92002)	92001-1859	2
SPACER (Ref # 92026)	92026-1146	1
CHAIN,CAM,75RH2015-174L (Ref # 92057)	92057-1226	1
SPRING,DECOMPRESSOR (Ref # 92081)	92081-1626	1
BOLT-FLANGED,8X25 (Ref # 130)	130G0825	1
BOLT-FLANGED,6X25 (Ref # 130A)	130J0625	2
SCREW-PAN-CROS,6X14 (Ref # 220)	220B0614	1
ROLLER,4X10 (Ref # 610)	610A0410	2