

# 1990 KLR650 PARTS DIAGRAM

Engine Cover

E1431

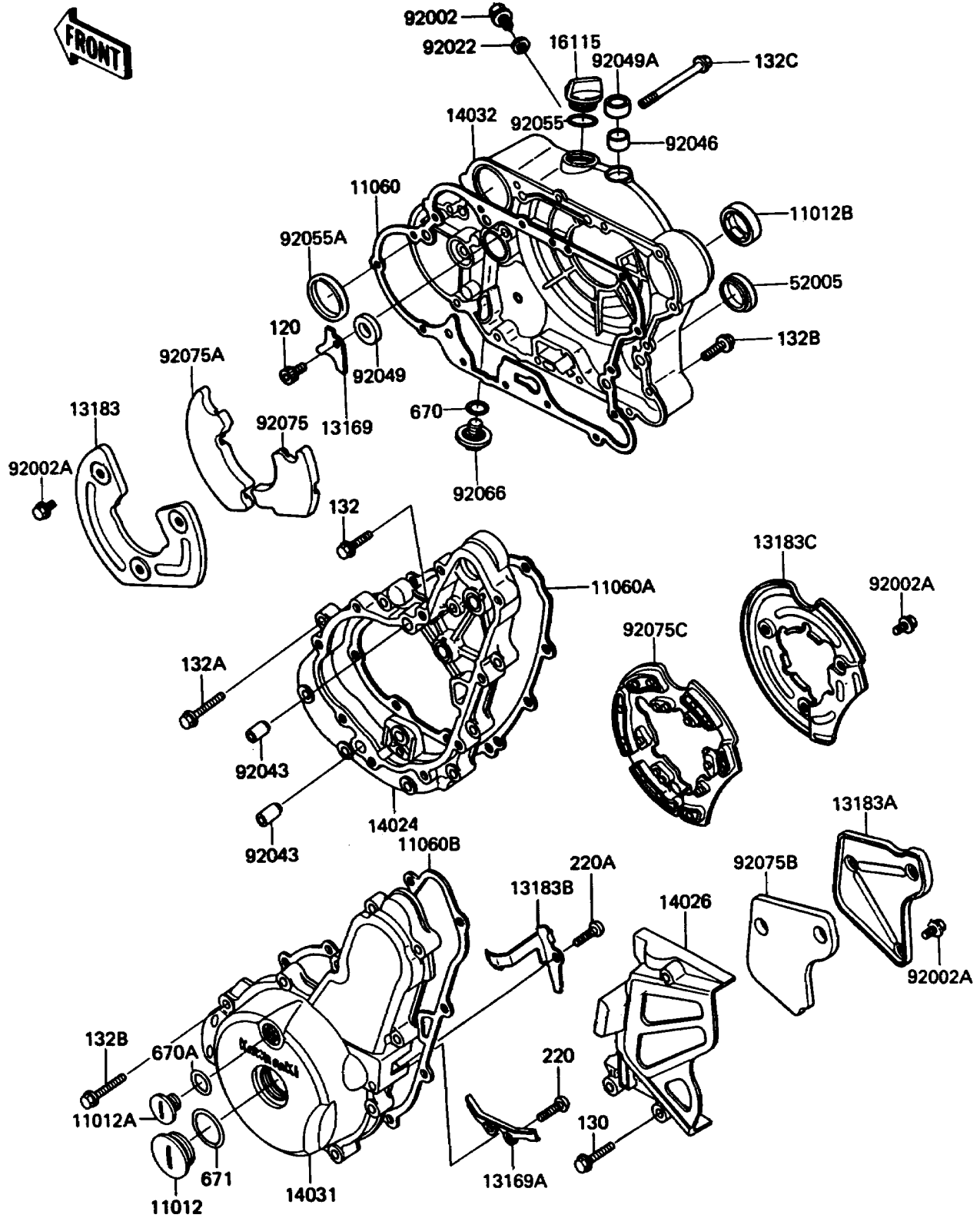

# 1990 KLR650 PARTS LIST

## Engine Cover

ITEM NAME	PART NUMBER	QUANTITY
CAP (Ref # 11012)	11012-1362	1
CAP,TOP MARK (Ref # 11012A)	11012-1363	1
CAP (Ref # 11012B)	11012-1567	1
GASKET,CLUTCH COVER (Ref # 11060)	11060-1111	1
GASKET,GENERATOR CASE COVER (Ref # 11060A)	11060-1112	1
GASKET,GENERATOR COVER (Ref # 11060B)	11060-1113	1
PLATE,OIL SEAL (Ref # 13169)	13169-1735	1
PLATE,PULSING COIL LEAD (Ref # 13169A)	13169-1882	1
PLATE (Ref # 13183)	13183-1122	1
PLATE (Ref # 13183A)	13183-1133	1
PLATE,GENERATOR (Ref # 13183B)	13183-1144	1
PLATE (Ref # 13183C)	13183-1146	1
COVER,GENERATOR CASE (Ref # 14024)	14025-1990	1
COVER-CHAIN (Ref # 14026)	14026-1131	1
COVER-GENERATOR (Ref # 14031)	14031-1210	1
COVER-CLUTCH (Ref # 14032)	14032-1230	1
CAP-OIL FILLER (Ref # 16115)	16115-1009	1
GAUGE,OIL LEVEL (Ref # 52005)	52005-1009	1
BOLT,CLUTCH RELEASE (Ref # 92002)	92002-1356	1
BOLT,6X8 (Ref # 92002A)	92002-1944	9
WASHER,6.2X11X1 (Ref # 92022)	92022-304	1
PIN,6.2X8X14 (Ref # 92043)	92043-1263	2
BEARING-NEEDLE,HK1210 (Ref # 92046)	92046-1010	1
SEAL-OIL,SCY 15X30X7 (Ref # 92049)	92049-1158	1
SEAL-OIL,TB12205.5 (Ref # 92049A)	92049-1271	1
RING-O,31.5X2.6 (Ref # 92055)	92055-049	1
RING-O,62.6X66X3.1 (Ref # 92055A)	92055-1221	1
PLUG,DRAIN (Ref # 92066)	92066-1156	1
DAMPER (Ref # 92075)	92075-1939	1

# 1990 KLR650 PARTS LIST

## Engine Cover

ITEM NAME	PART NUMBER	QUANTITY
DAMPER (Ref # 92075A)	92075-1940	1
DAMPER (Ref # 92075B)	92075-1943	1
DAMPER (Ref # 92075C)	92075-1959	1
BOLT-SOCKET,6X10 (Ref # 120)	120P0610	1
BOLT-FLANGED,6X25 (Ref # 130)	130J0625	3
BOLT-FLANGED-SMALL (Ref # 132)	132J0620	1
BOLT-FLANGED-SMALL (Ref # 132A)	132J0625	8
BOLT-FLANGED-SMALL (Ref # 132B)	132J0630	24
BOLT-FLANGED-SMALL (Ref # 132C)	132J0680	1
SCREW-PAN-CROS (Ref # 220)	220B0510	2
SCREW-PAN-CROS,6X12 (Ref # 220A)	220B0612	1
O RING,11MM (Ref # 670)	670B2011	1
O RING,18MM (Ref # 670A)	670B2018	1
O RING,40MM (Ref # 671)	671B2540	1