

2004 KLR650 PARTS DIAGRAM

Cylinder/Piston(s)

E1120

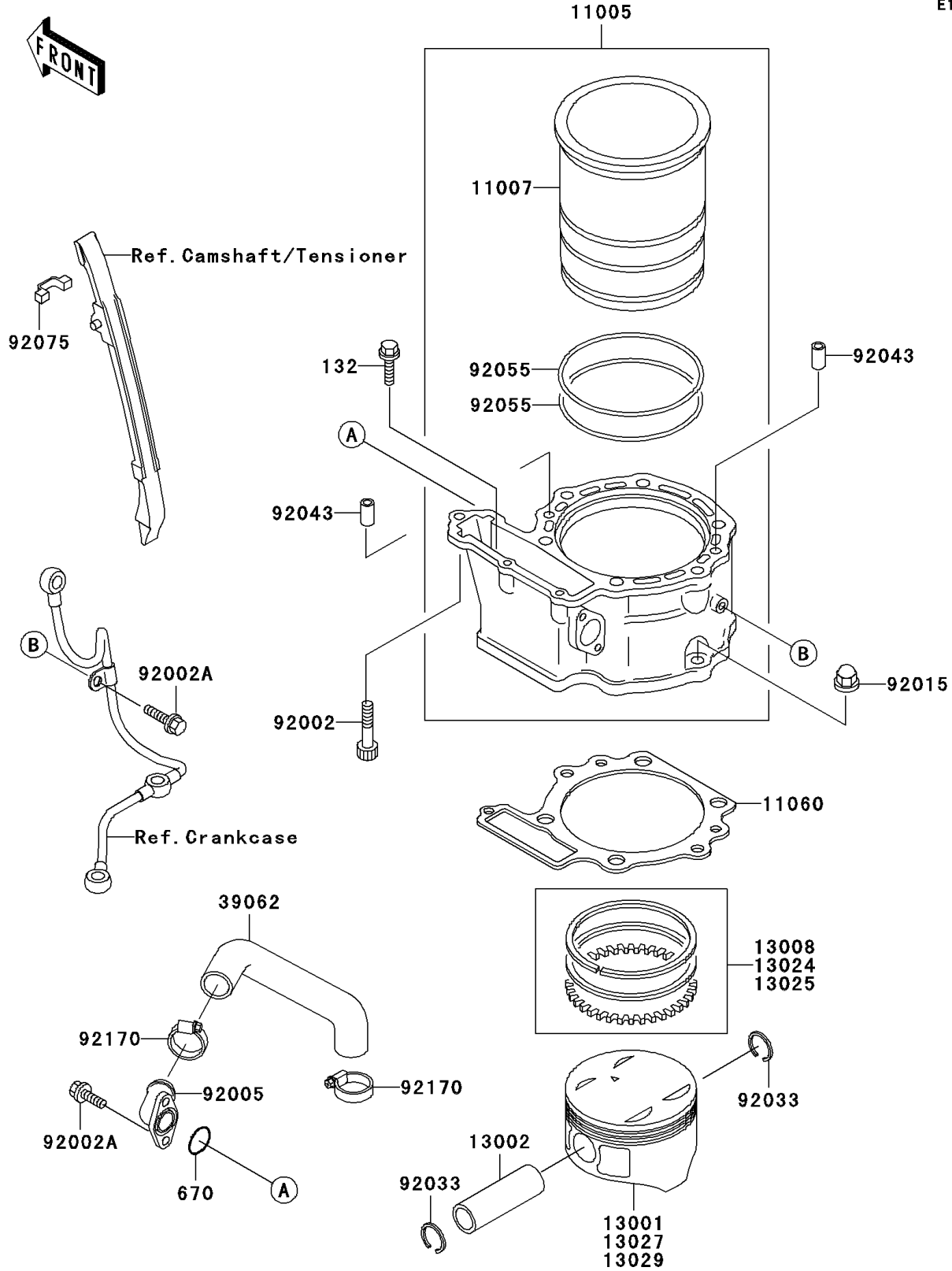

2004 KLR650 PARTS LIST

Cylinder/Piston(s)

ITEM NAME	PART NUMBER	QUANTITY
BOLT-FLANGED-SMALL (Ref # 132)	132G0625	1
O RING,18MM (Ref # 670)	670B2018	1
CYLINDER-ENGINE (Ref # 11005)	11005-1781	1
LINER-CYLINDER (Ref # 11007)	11007-1137	1
GASKET,CYLINDER BASE (Ref # 11060)	11060-1110	1
PISTON-ENGINE,STD (Ref # 13001)	13001-1284	1
PIN-PISTON (Ref # 13002)	13002-1101	1
RING-SET-PISTON,STD (Ref # 13008)	13008-1081	1
RING-SET-PISTON LL,O/S 1.00 (Ref # 13024)	13024-1071	1
RING-SET-PISTON L,O/S 0.50 (Ref # 13025)	13025-1078	1
PISTON-ENGINE LL,O/S 1.00 (Ref # 13027)	13027-1153	1
PISTON-ENGINE L,O/S 0.50 (Ref # 13029)	13029-1176	1
HOSE-COOLING,PUMP-CYLINDER (Ref # 39062)	39062-1216	1
BOLT,SOCKET,8X35 (Ref # 92002)	92002-1409	1
BOLT,6X12 (Ref # 92002A)	92002-1569	3
FITTING (Ref # 92005)	92005-1279	1
NUT,CAP,8MM (Ref # 92015)	92015-1982	4
RING-SNAP (Ref # 92033)	92033-1226	2
PIN,6.2X8X14 (Ref # 92043)	92043-1263	2
RING-O,110.5X2.5 (Ref # 92055)	92055-1371	2
DAMPER (Ref # 92075)	92075-1968	1
CLAMP,COOLING HOSE (Ref # 92170)	92170-1033	2