

2001 KLR650 PARTS DIAGRAM

Generator

E1810

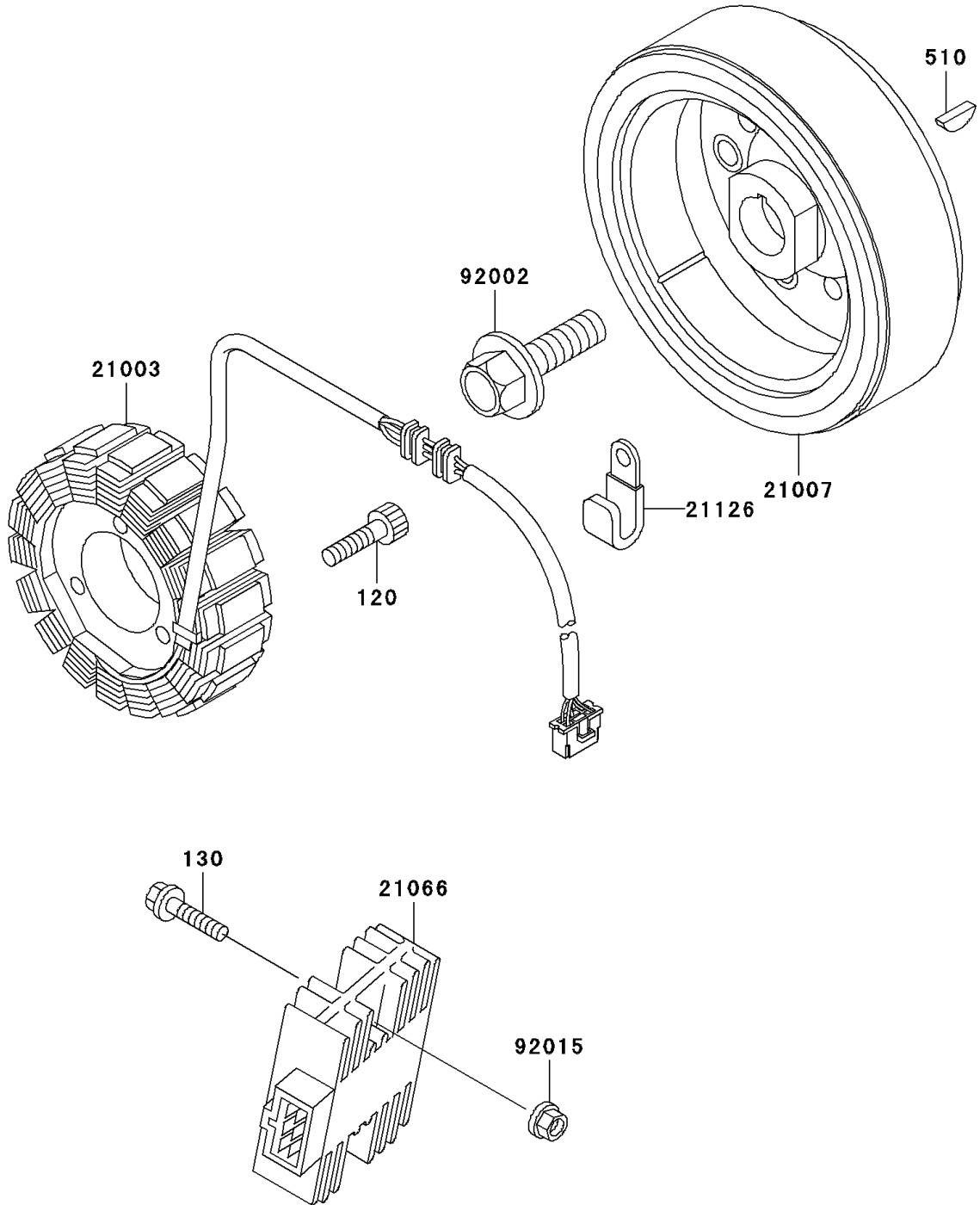

2001 KLR650 PARTS LIST

Generator

ITEM NAME	PART NUMBER	QUANTITY
BOLT-SOCKET,6X28 (Ref # 120)	120P0628	3
BOLT-FLANGED,6X25 (Ref # 130)	130J0625	2
KEY-WOODRUFF (Ref # 510)	510A4200	1
STATOR (Ref # 21003)	21003-1170	1
ROTOR (Ref # 21007)	21007-1283	1
REGULATOR-VOLTAGE (Ref # 21066)	21066-1038	1
CLAMP,WIRING HARNESS (Ref # 21126)	21126-008	1
BOLT,FLANGED,12X40 (Ref # 92002)	92002-1693	1
NUT,FLANGED,6MM (Ref # 92015)	92015-1078	2