

2003 KLR650 PARTS DIAGRAM

Rear Hub

F2240

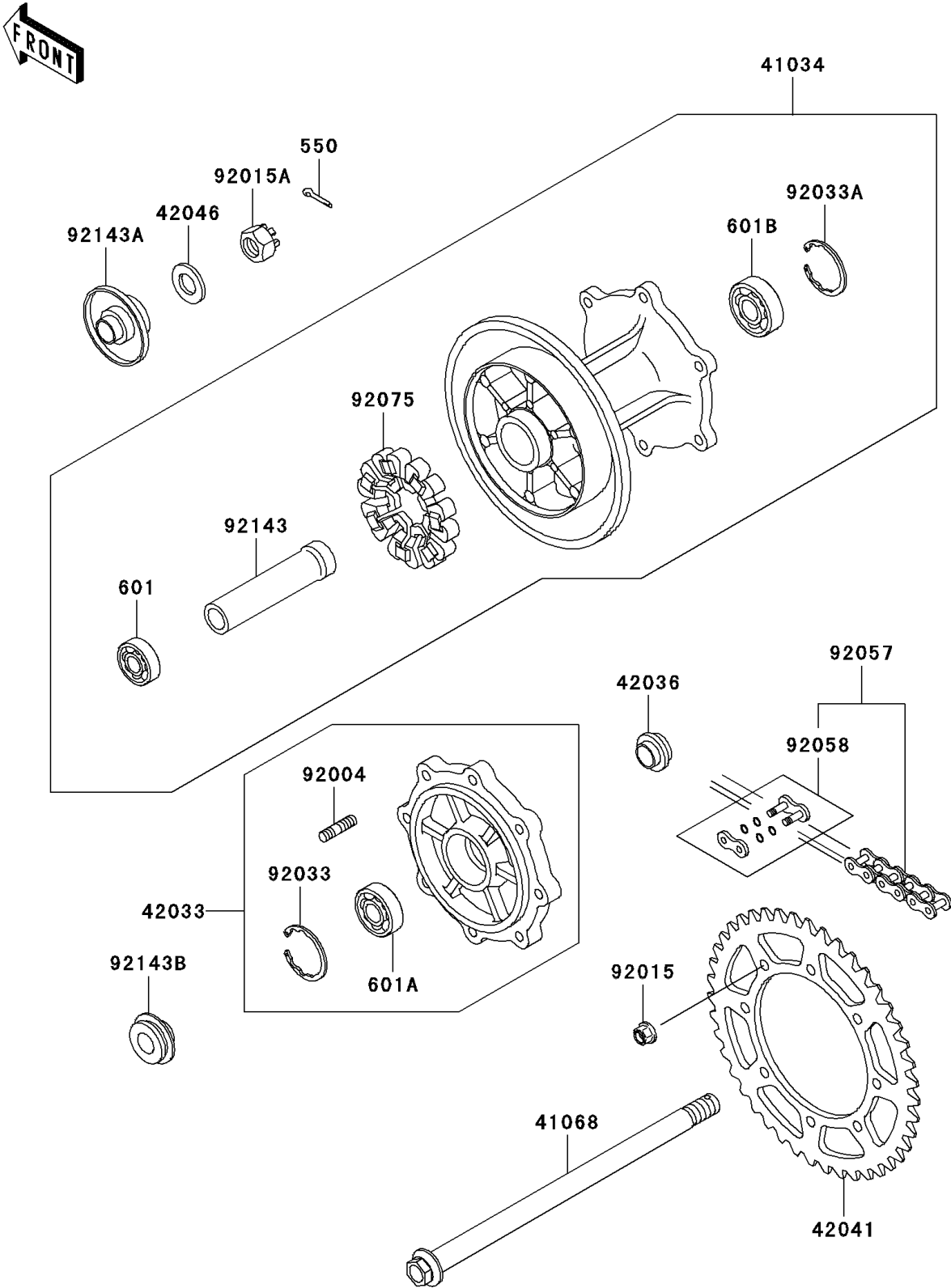

2003 KLR650 PARTS LIST

Rear Hub

ITEM NAME	PART NUMBER	QUANTITY
PIN-COTTER,4.0X35 (Ref # 550)	550D4035	1
BEARING-BALL,#6003G (Ref # 601)	601B6003G	1
BEARING-BALL,#6004UG (Ref # 601A)	601B6004UG	1
BEARING-BALL,#6204UG (Ref # 601B)	601B6204UG	1
DRUM-ASSY,REAR BRAKE (Ref # 41034)	41034-1154	1
AXLE,RR (Ref # 41068)	41068-1237	1
COUPLING-ASSY,REAR HUB (Ref # 42033)	42033-1112	1
SLEEVE,REAR AXLE,L=16 (Ref # 42036)	42036-1206	1
SPROCKET-HUB,43T (Ref # 42041)	42041-1260	1
WASHER,17.3X32X3.2 (Ref # 42046)	42046-009	1
STUD,8X16 (Ref # 92004)	92004-1150	8
NUT,8MM (Ref # 92015)	92015-1432	8
NUT,CASTLE,16MM (Ref # 92015A)	92015-1947	1
RING-SNAP,42MM (Ref # 92033)	92033-1041	1
RING-SNAP,47MM (Ref # 92033A)	92033-1042	1
CHAIN,DRIVE,EK520SR-O2X106L (Ref # 92057)	92057-0019	1
JOINT-CHAIN,DRIVE (Ref # 92058)	92058-1102	1
DAMPER,SHOCK,RR HUB (Ref # 92075)	92075-1068	1
COLLAR,REAR BRAKE DRUM,L=113 (Ref # 92143)	92143-1060	1
COLLAR,REAR AXLE,L=30 (Ref # 92143A)	92143-1061	1
COLLAR,REAR AXLE,L=17 (Ref # 92143B)	92143-1062	1