

1993 KLR650 PARTS DIAGRAM

Cylinder Head

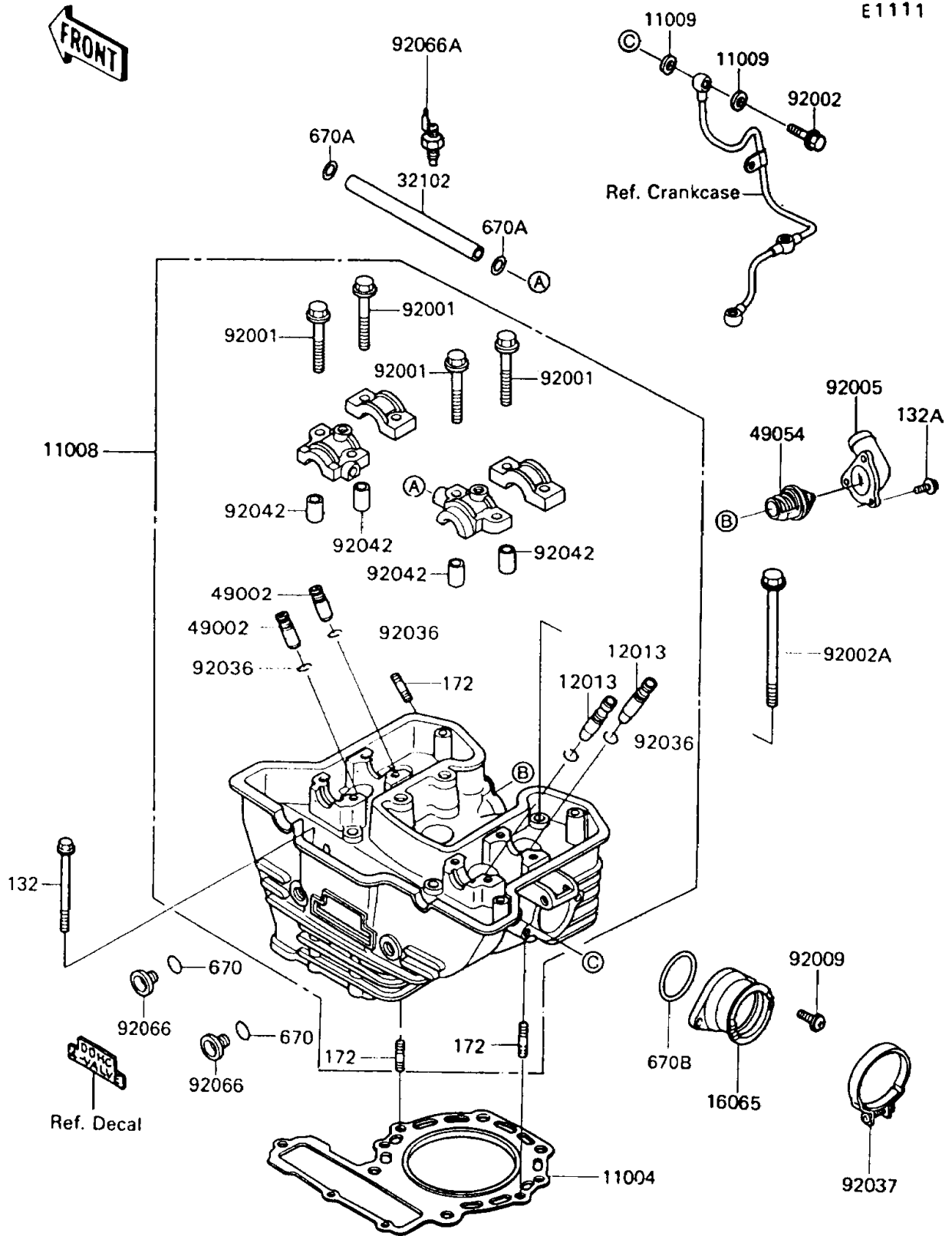

1993 KLR650 PARTS LIST

Cylinder Head

ITEM NAME	PART NUMBER	QUANTITY
GASKET-HEAD (Ref # 11004)	11004-1158	1
HEAD-COMP-CYLINDER (Ref # 11008)	11008-1202	1
GASKET,10X14.5X1.5 (Ref # 11009)	11009-1105	2
GUIDE-VALVE,INTAKE (Ref # 12013)	12013-009	AR
HOLDER-CARBURETOR (Ref # 16065)	16065-1151	1
PIPE,OIL LINE (Ref # 32102)	32102-1352	1
GUIDE-VALVE,EXHAUST (Ref # 49002)	49002-1002	AR
THERMOSTAT (Ref # 49054)	49054-1053	1
BOLT,FLANGED,6X38 (Ref # 92001)	92001-1105	8
BOLT,BANJO,10X25 (Ref # 92002)	92002-1170	1
BOLT,10X191 (Ref # 92002A)	92002-1874	4
FITTING (Ref # 92005)	92005-1121	1
SCREW,6X20 (Ref # 92009)	92009-1325	2
RING-SNAP (Ref # 92036)	92036-023	4
CLAMP,55MM (Ref # 92037)	92037-1486	1
PIN,DOWEL,6.3X8X14 (Ref # 92042)	92042-007	8
PLUG (Ref # 92066)	92066-1158	2
PLUG,SENSOR WATER (Ref # 92066A)	92066-1183	1
BOLT-FLANGED-SMALL (Ref # 132)	132H0685	2
BOLT-FLANGED-SMALL (Ref # 132A)	132J0612	3
BOLT-STUD,8X22 (Ref # 172)	172G0822	4
O RING,15MM (Ref # 670)	670B2015	2
O RING,6MM (Ref # 670A)	670D1506	2
O RING,48MM (Ref # 670B)	670D3048	1