

1994 KLR650 PARTS DIAGRAM

Fuel Evaporative System

E1650

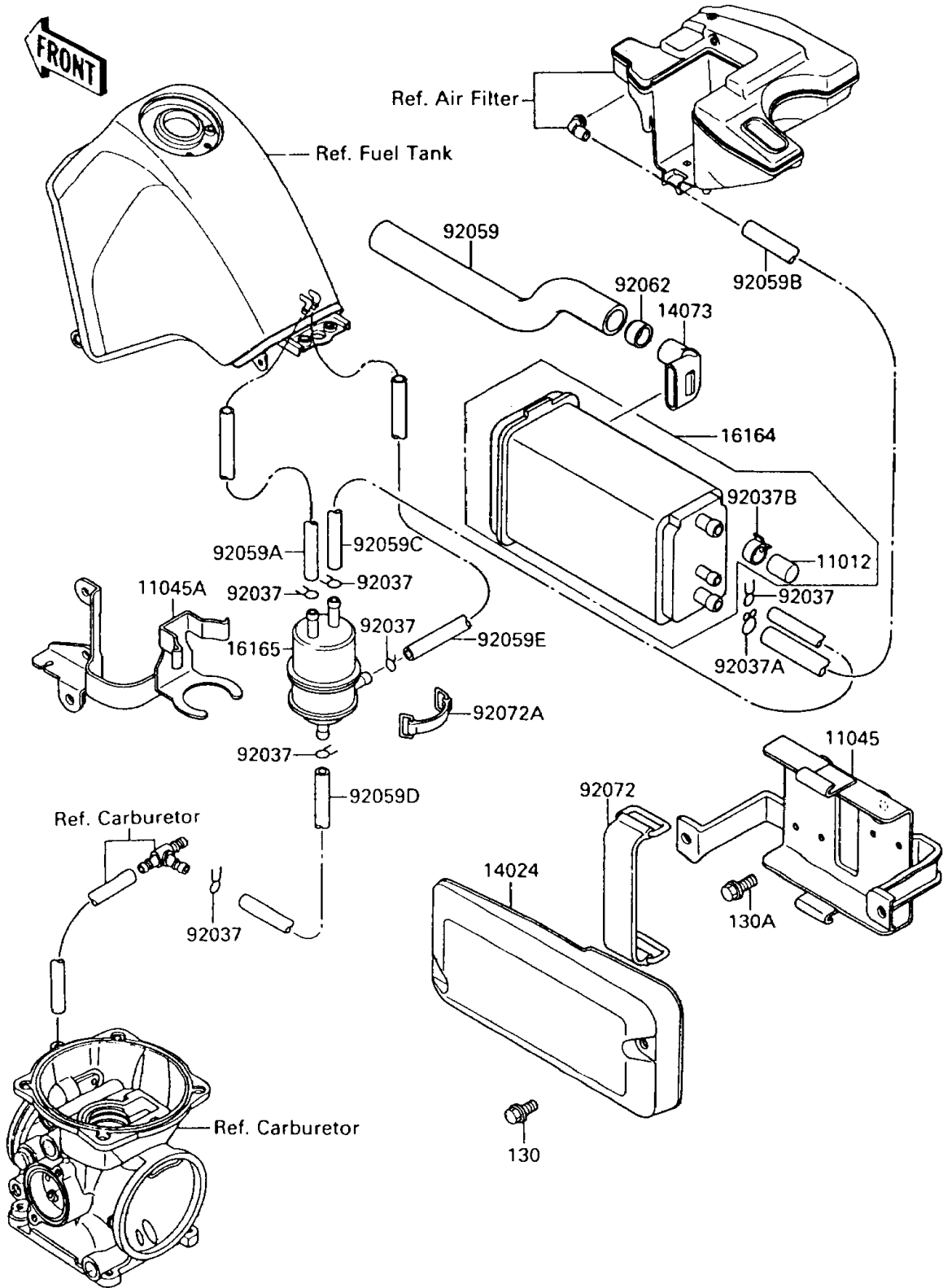

1994 KLR650 PARTS LIST

Fuel Evaporative System

ITEM NAME	PART NUMBER	QUANTITY
CAP,CANISTER (Ref # 11012)	11012-1388	1
BRACKET,CANISTER (Ref # 11045)	11045-1416	1
BRACKET,SEPARATOR (Ref # 11045A)	11045-1417	1
COVER,CANISTER (Ref # 14024)	14024-1401	1
DUCT,CANISTER (Ref # 14073)	14073-1219	1
CANISTER (Ref # 16164)	16164-1054	1
SEPARATOR (Ref # 16165)	16165-1001	1
CLAMP,TUBE (Ref # 92037)	92037-072	6
CLAMP,HOSE (Ref # 92037A)	92037-1104	1
CLAMP,CANISTER (Ref # 92037B)	92037-1512	1
TUBE,14X20X200 (Ref # 92059)	92059-1800	1
TUBE,5X9X890,BLUE (Ref # 92059A)	92059-1801	1
TUBE,7X12X770,GREEN (Ref # 92059B)	92059-1802	1
TUBE,5X9X300,RED (Ref # 92059C)	92059-1803	1
TUBE,4X9X310,WHITE (Ref # 92059D)	92059-1804	1
TUBE,5X9X400,BLUE (Ref # 92059E)	92059-1805	1
NOZZLE,CANISTER (Ref # 92062)	92062-1070	1
BAND,L=90 (Ref # 92072)	92072-045	1
BAND,L=50 (Ref # 92072A)	92072-066	1
BOLT-FLANGED (Ref # 130)	130C0608	2
BOLT-FLANGED (Ref # 130A)	130J0612	2