

1994 KLR650 PARTS DIAGRAM

Frame Fittings

F2131

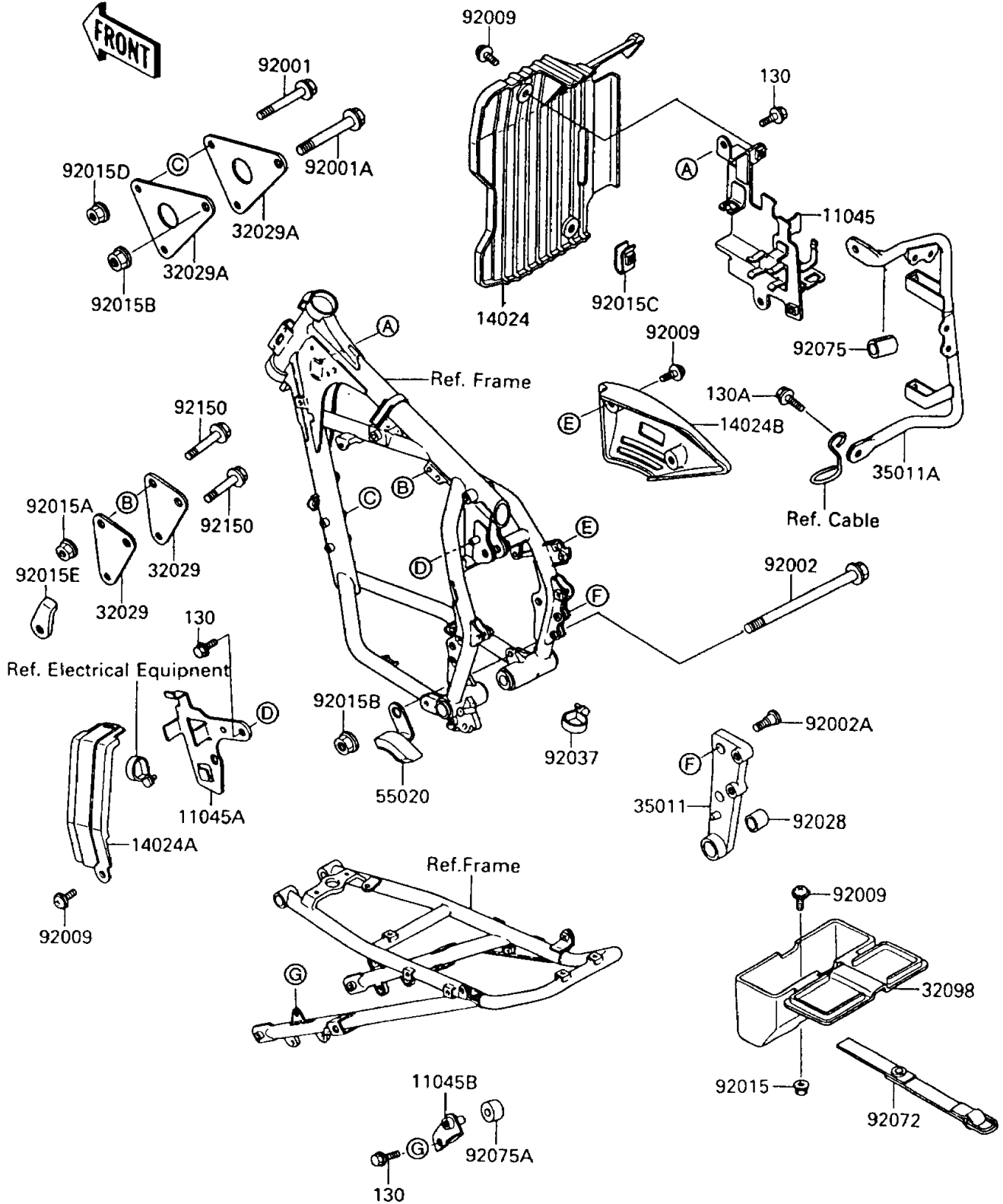

1994 KLR650 PARTS LIST

Frame Fittings

ITEM NAME	PART NUMBER	QUANTITY
BRACKET,ELECTRIC,RH (Ref # 11045)	11045-1358	1
BRACKET,ELECTRIC,LH (Ref # 11045A)	11045-1359	1
BRACKET (Ref # 11045B)	11045-1360	1
COVER,FRONT RESERVOIR (Ref # 14024)	14024-1372	1
COVER,SIDE STAND SWITCH (Ref # 14024A)	14024-1373	1
COVER,RESERVOIR TANK (Ref # 14024B)	14024-1470	1
BRACKET-ENGINE (Ref # 32029)	32029-1685	2
BRACKET-ENGINE,FR (Ref # 32029A)	32029-1805	2
CASE-TOOL,P.WHITE (Ref # 32098)	32098-1074-6F	1
STAY (Ref # 35011)	35011-1327	1
STAY,HORN&RESERVOIR TANK (Ref # 35011A)	35011-1370	1
GUARD,CHAIN (Ref # 55020)	55020-1266	1
BOLT,FLANGED,8X70 (Ref # 92001)	92001-1583	2
BOLT,10X75 (Ref # 92001A)	92001-4021	1
BOLT,10X145 (Ref # 92002)	92002-1348	1
BOLT,SOCKET,8X23.5 (Ref # 92002A)	92002-1598	2
SCREW,6X14 (Ref # 92009)	92009-1288	7
NUT,FLANGED,6MM (Ref # 92015)	92015-1233	1
NUT,FLANGED,8MM (Ref # 92015A)	92015-1406	2
NUT,FLANGED,10MM (Ref # 92015B)	92015-1415	2
NUT,6MM (Ref # 92015C)	92015-1602	1
NUT,FLANGED,LOCK,8MM (Ref # 92015D)	92015-1668	2
NUT,PLATE,8MM (Ref # 92015E)	92015-1673	1
BUSHING (Ref # 92028)	92028-1259	1
CLAMP (Ref # 92037)	92037-1903	1
BAND,TOOL CASE (Ref # 92072)	92072-1219	1
DAMPER (Ref # 92075)	92075-1941	1
DAMPER (Ref # 92075A)	92075-243	1
BOLT,FLANGED,8X42 (Ref # 92150)	92150-1415	3

1994 KLR650 PARTS LIST

Frame Fittings

ITEM NAME	PART NUMBER	QUANTITY
BOLT-FLANGED (Ref # 130)	130J0612	4
BOLT-FLANGED,6X14,BLACK (Ref # 130A)	130J0614	2