

# 1995 KLR650 PARTS DIAGRAM

Swingarm

F2141

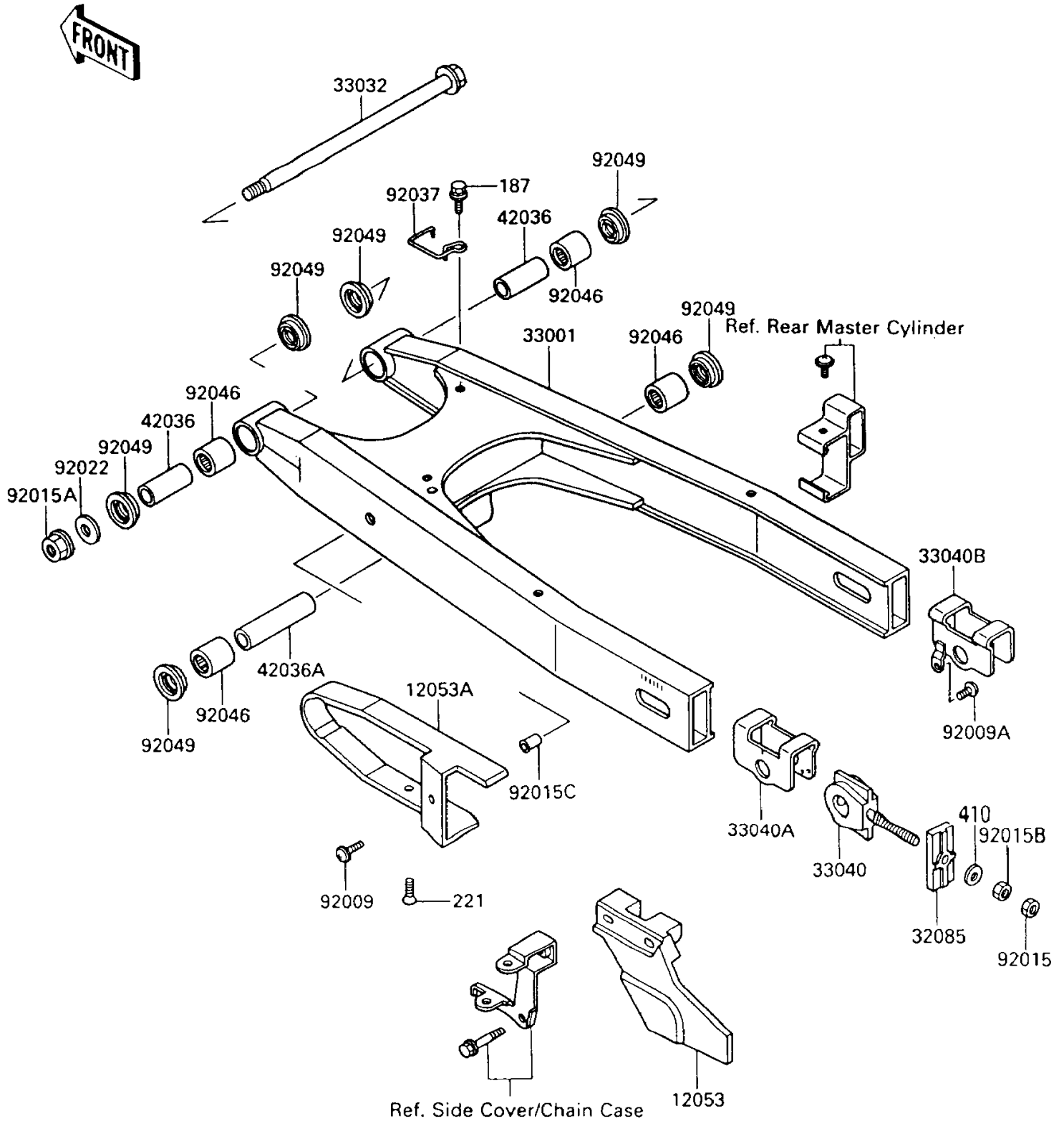

# 1995 KLR650 PARTS LIST

## Swingarm

ITEM NAME	PART NUMBER	QUANTITY
GUIDE-CHAIN,RR (Ref # 12053)	12053-1104	1
GUIDE-CHAIN,DRIVE,FR (Ref # 12053A)	12053-1293	1
STOPPER,CHAIN ADJUSTER (Ref # 32085)	32085-1256	2
ARM-COMP-SWING,SILVER NO.25 (Ref # 33001)	33001-1278-CE	1
SHAFT-SWING ARM (Ref # 33032)	33032-1128	1
ADJUSTER-CHAIN,INNER (Ref # 33040)	33040-1075	2
ADJUSTER-CHAIN,OUTER (Ref # 33040A)	33040-1076	1
ADJUSTER-CHAIN,OUTER (Ref # 33040B)	33040-1078	1
SLEEVE,15X20X47.5 (Ref # 42036)	42036-1204	2
SLEEVE,15X20X82 (Ref # 42036A)	42036-1205	1
SCREW,6X14 (Ref # 92009)	92009-1288	1
SCREW,5X10 (Ref # 92009A)	92009-1651	1
NUT,8MM (Ref # 92015)	92015-1364	2
NUT,14MM (Ref # 92015A)	92015-1459	1
NUT,8MM (Ref # 92015B)	92015-1658	2
NUT,CRIMP 6MM (Ref # 92015C)	92015-1796	1
WASHER,16X32X3.2 (Ref # 92022)	92022-1701	1
CLAMP,HOSE (Ref # 92037)	92037-1902	1
BEARING-NEEDLE,BM202726 (Ref # 92046)	92046-1110	4
SEAL-OIL,ARM,CNT (Ref # 92049)	92049-1109	6
BOLT-UPSET-WSP (Ref # 187)	187D0610	1
SCREW-CSK-CROS,6X10 (Ref # 221)	221B0610	1
WASHER-PLAIN-SMALL,8MM (Ref # 410)	410B0800	2