

1992 KLR650 PARTS DIAGRAM

Labels

F2860

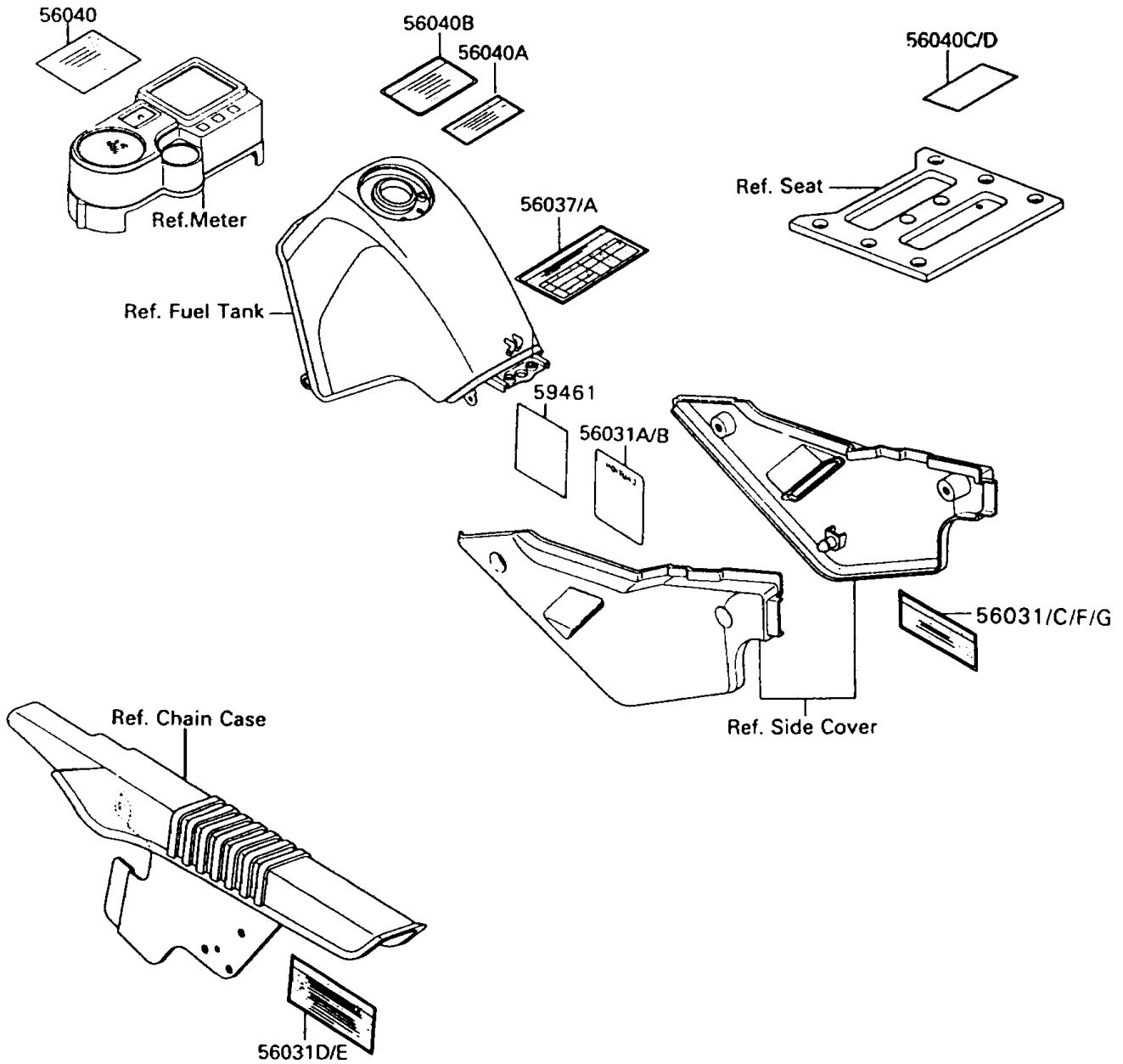

1992 KLR650 PARTS LIST

Labels

ITEM NAME	PART NUMBER	QUANTITY
LABEL-MANUAL,OIL & OIL FILTER (Ref # 56031)	56031-1534	1
LABEL-MANUAL,BATTERY VENT (Ref # 56031A)	56031-1536	1
LABEL-MANUAL,BATTERY VENT (Ref # 56031B)	56031-1540	1
LABEL-MANUAL,OIL & OIL FILTER (Ref # 56031C)	56031-1541	1
LABEL-MANUAL,CHAIN (Ref # 56031D)	56031-1622	1
LABEL-MANUAL,CHAIN (Ref # 56031E)	56031-1623	1
LABEL-SPECIFICATION,TIRE&LOAD (Ref # 56037)	56037-1371	1
LABEL-SPECIFICATION,TIRE&LOAD (Ref # 56037A)	56037-1543	1
LABEL-WARNING,BREAK IN CAUTION (Ref # 56040)	56040-1007	1
LABEL-WARNING,BREAK IN CAUTION (Ref # 56040A)	56040-1008	1
LABEL-WARNING,EVAPO (Ref # 56040B)	56040-1121	1
LABEL-WARNING,CARRIER (Ref # 56040C)	56040-1212	1
LABEL-WARNING,CARRIER (Ref # 56040D)	56040-1215	1
LABEL-CERTIFICATION,EVAPO ROUT (Ref # 59461)	59461-1776	1