

2006 KLR650 PARTS DIAGRAM

Seat

F2510

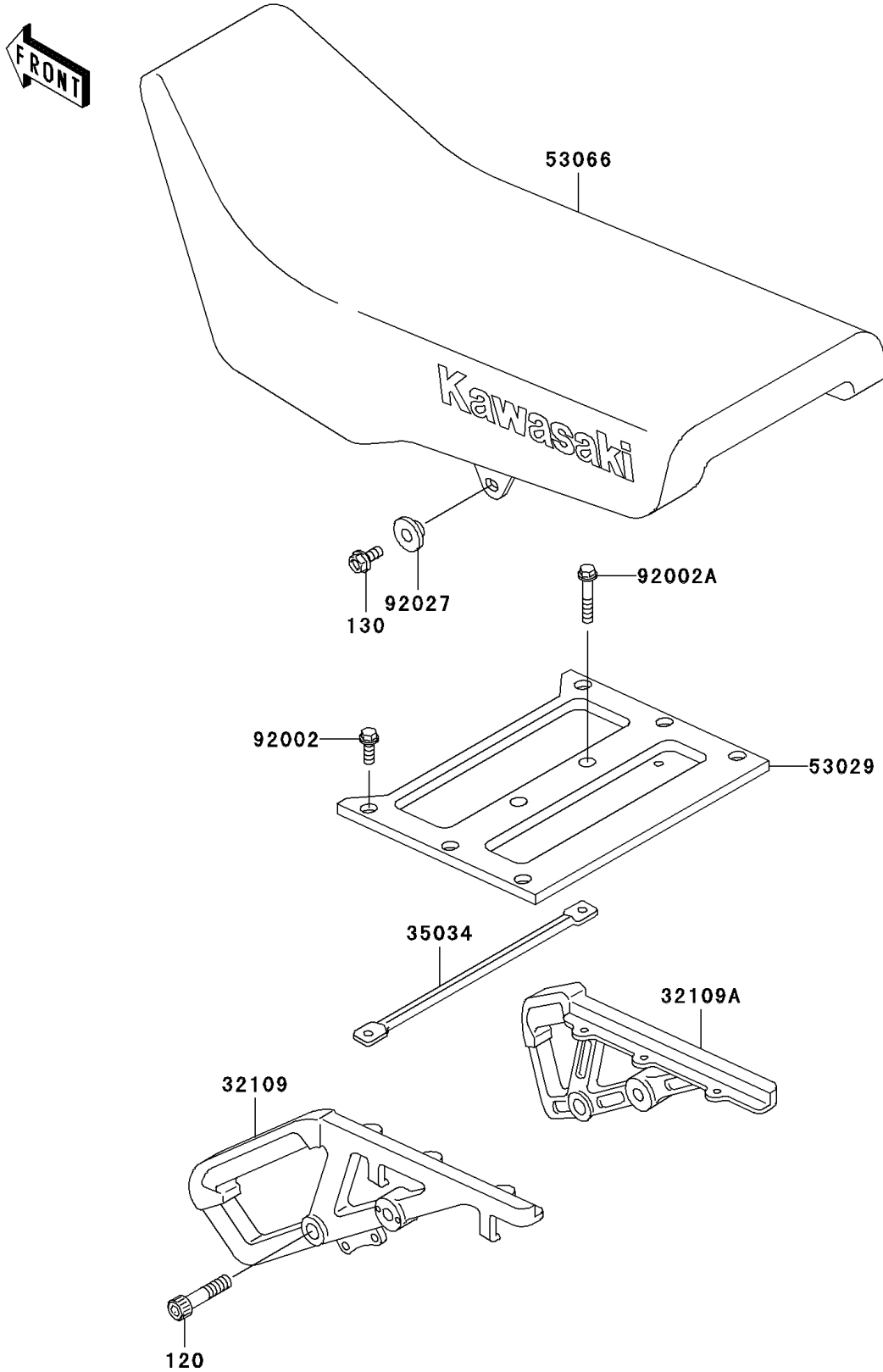

2006 KLR650 PARTS LIST

Seat

ITEM NAME	PART NUMBER	QUANTITY
BOLT-SOCKET,8X35 (Ref # 120)	120P0835	2
BOLT-FLANGED,6X14 (Ref # 130)	130H0614	2
GRIP-FRAME,LH,SILVER NO.25 (Ref # 32109)	32109-1152-CE	1
GRIP-FRAME,RH,SILVER NO.25 (Ref # 32109A)	32109-1153-CE	1
REINFORCE (Ref # 35034)	35034-1207	1
CARRIER (Ref # 53029)	53029-1081	1
SEAT-ASSY,DUAL,BLACK (Ref # 53066)	53066-1062-MW	1
BOLT,6X16 (Ref # 92002)	92002-1933	6
BOLT,FLANGED,6X32 (Ref # 92002A)	92002-1989	2
COLLAR (Ref # 92027)	92027-1794	2