

# 2006 KLR650 PARTS DIAGRAM

Ignition Switch

F2770

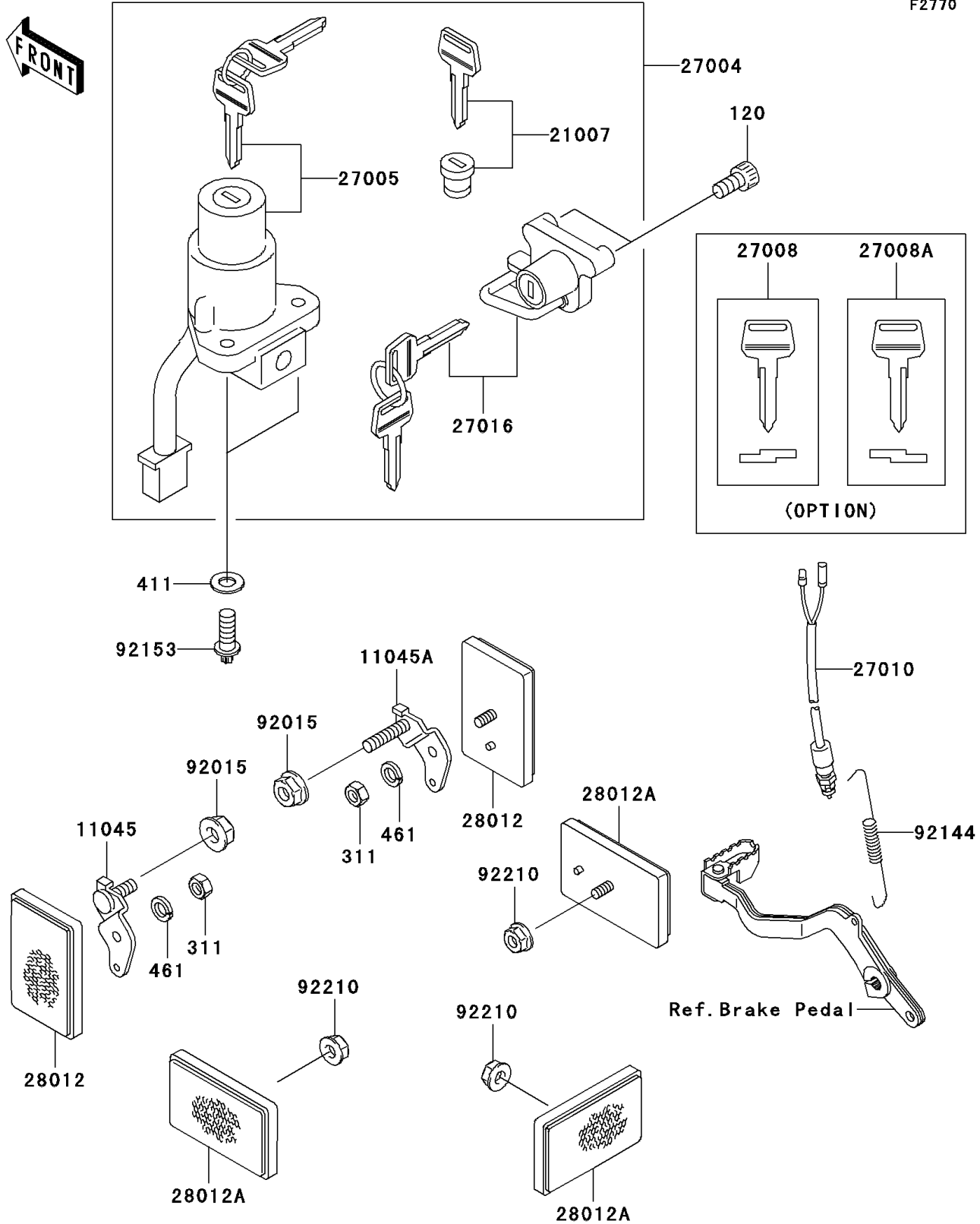

## 2006 KLR650 PARTS LIST

### Ignition Switch

ITEM NAME	PART NUMBER	QUANTITY
BOLT-SOCKET,6X12 (Ref # 120)	120S0612	2
NUT-HEX (Ref # 311)	311C0500	2
WASHER-PLAIN,6MM (Ref # 411)	411E0600	2
WASHER-SPRING,5MM,BLACK (Ref # 461)	461K0500	2
BRACKET,REFLECTOR,FR (Ref # 11045)	11045-1354	1
BRACKET,REFLECTOR,FR (Ref # 11045A)	11045-1355	1
ROTOR,LOCK,TANK CAP (Ref # 21007)	21007-5022	1
SWITCH-ASSY (Ref # 27004)	27004-5322	1
SWITCH-ASSY-IGNITION (Ref # 27005)	27005-1129	1
KEY-LOCK,BLANK,#A (Ref # 27008)	27008-1034	1
KEY-LOCK,BLANK,#B (Ref # 27008A)	27008-1035	1
SWITCH,REAR BRAKE (Ref # 27010)	27010-1484	1
LOCK-ASSY,HELMET (Ref # 27016)	27016-5075	1
REFLECTOR-REFLEX (Ref # 28012)	28012-1003	2
REFLECTOR-REFLEX (Ref # 28012A)	28012-1088	3
NUT,FLANGED,6MM,BLACK (Ref # 92015)	92015-1233	2
SPRING,REAR BRAKE SWITCH (Ref # 92144)	92144-1093	1
BOLT,TORX,6X16 (Ref # 92153)	92153-0967	2
NUT,FLANGED,5MM (Ref # 92210)	92210-0007	3