

1991 Tengai PARTS DIAGRAM

Crankcase

E1411

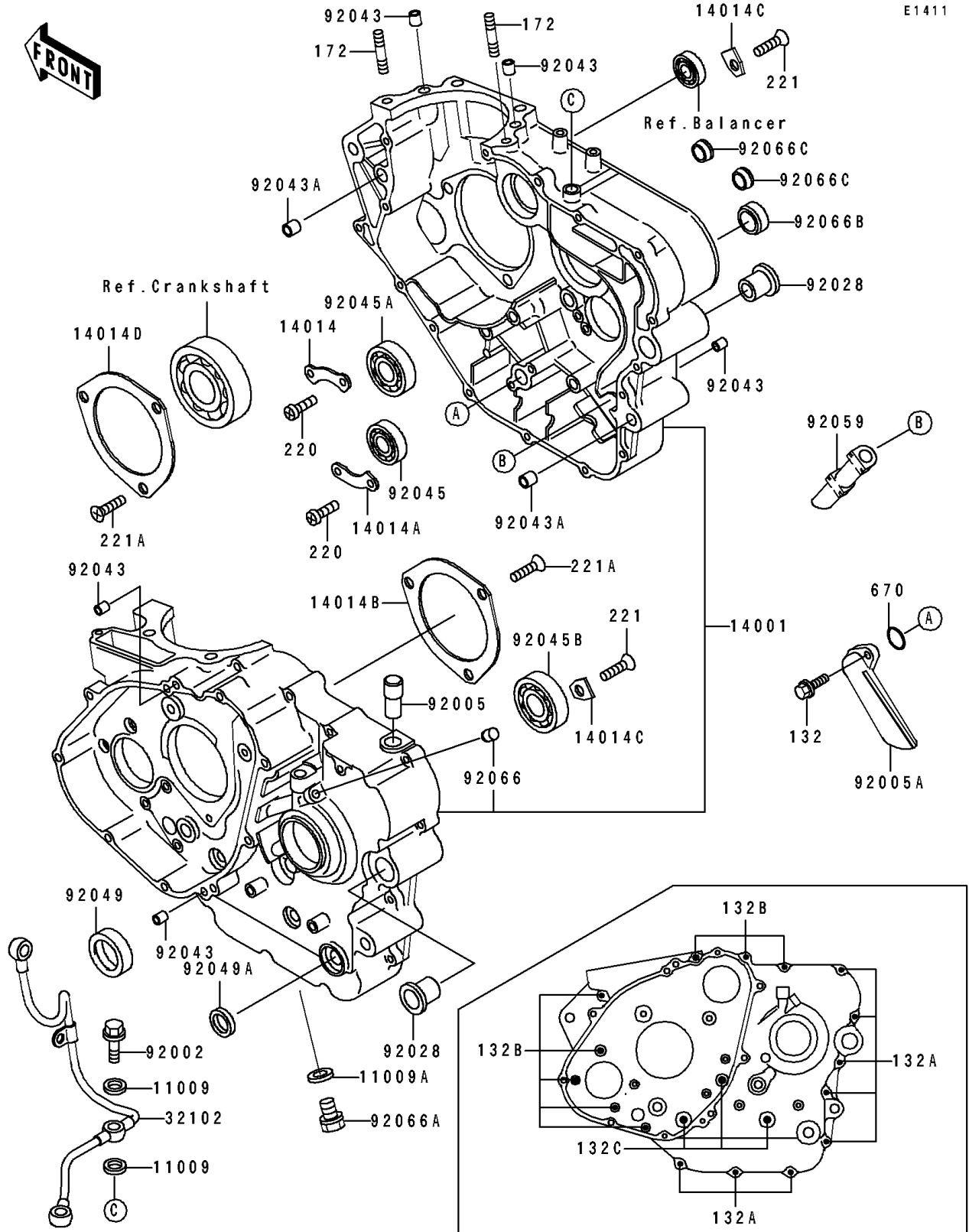

1991 Tengai PARTS LIST

Crankcase

ITEM NAME	PART NUMBER	QUANTITY
GASKET,10X14.5X1.5 (Ref # 11009)	11009-1105	4
GASKET,12X22X2,DRAIN PLUG (Ref # 11009A)	92065-097	1
SET-CRANKCASE (Ref # 14001)	14001-5266	1
PLATE-POSITION,CHANGE DRUM (Ref # 14014)	14014-037	1
PLATE-POSITION (Ref # 14014A)	14014-1015	1
PLATE-POSITION (Ref # 14014B)	14014-1051	1
PLATE-POSITION (Ref # 14014C)	14014-1057	2
PLATE-POSITION (Ref # 14014D)	14014-1083	1
PIPE (Ref # 32102)	32102-1353	1
BOLT,BANJO,10X25 (Ref # 92002)	92002-1170	2
FITTING,BREATHER (Ref # 92005)	14067-006	1
FITTING (Ref # 92005A)	92005-1152	1
BUSHING,SWING ARM (Ref # 92028)	92028-1261	2
PIN,6.2X8X14 (Ref # 92043)	92043-1263	6
PIN,11.5X14X14 (Ref # 92043A)	92043-1279	2
BEARING-BALL,#6905 (Ref # 92045)	92045-036	1
BEARING-BALL,TMB205 (Ref # 92045A)	92045-1105	1
BEARING-BALL,TM-SX0597LU (Ref # 92045B)	92045-1127	1
SEAL-OIL,TC32457 (Ref # 92049)	92049-1159	1
SEAL-OIL (Ref # 92049A)	92050-082	1
TUBE,BREATHER (Ref # 92059)	92059-1833	1
PLUG (Ref # 92066)	92066-1012	1
PLUG,OIL DRAIN,12X15 (Ref # 92066A)	92066-1174	1
PLUG,RCA207 (Ref # 92066B)	92066-1264	1
PLUG (Ref # 92066C)	92066-1282	2
BOLT-FLANGED-SMALL (Ref # 132)	132G0620	2
BOLT-FLANGED-SMALL (Ref # 132A)	132J0630	8
BOLT-FLANGED-SMALL (Ref # 132B)	132J0650	8
BOLT-FLANGED-SMALL (Ref # 132C)	132J0880	3

1991 Tengai PARTS LIST

Crankcase

ITEM NAME	PART NUMBER	QUANTITY
BOLT-STUD,8X22 (Ref # 172)	172G0822	2
SCREW-PAN-CROS,6X12 (Ref # 220)	220B0612	4
SCREW-CSK-CROS,6X12 (Ref # 221)	221B0612	2
SCREW-CSK-CROS,6X16 (Ref # 221A)	221B0616	6
O RING (Ref # 670)	670D2018	1