

# 1991 Tengai PARTS DIAGRAM

Radiator

E3032

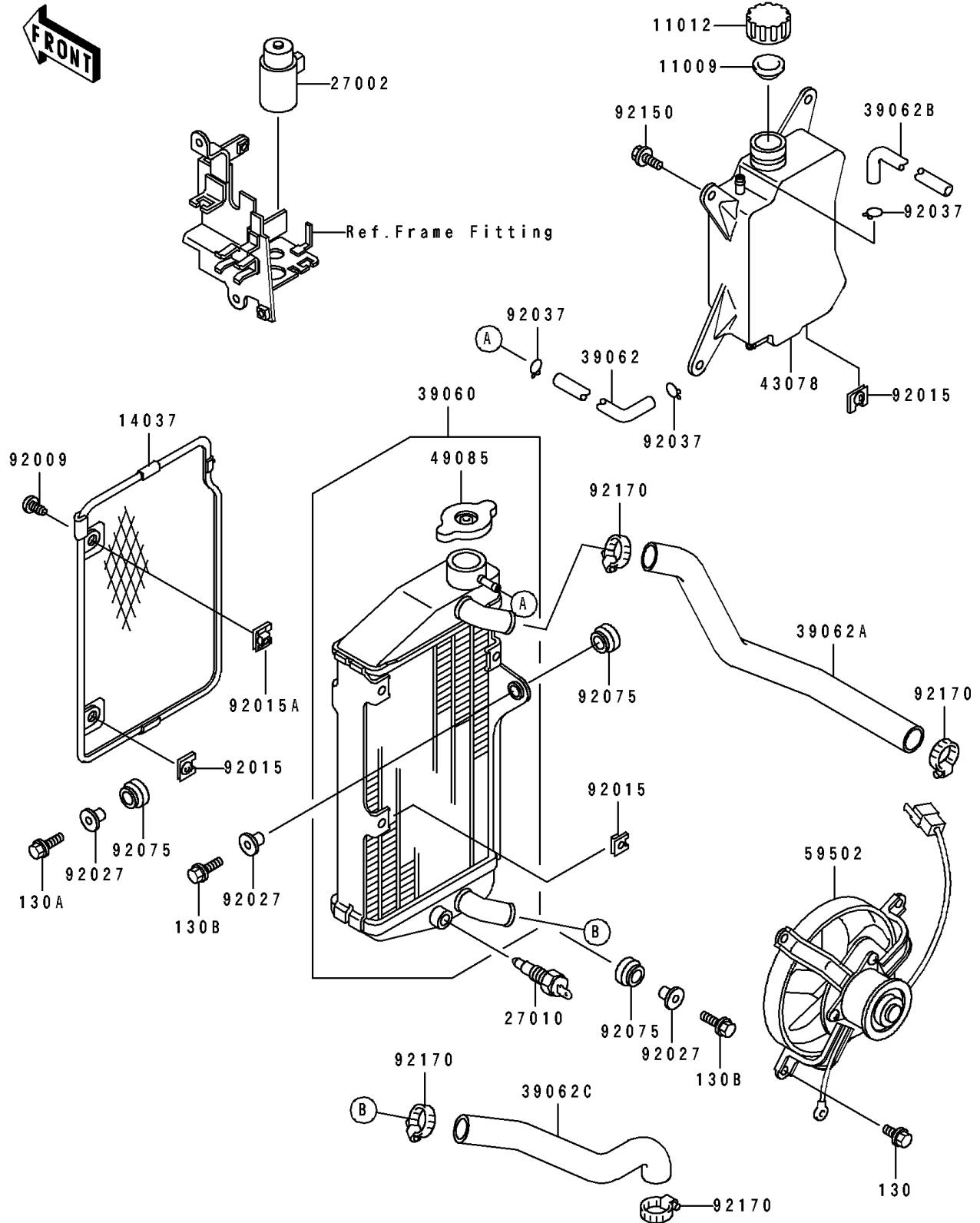

# 1991 Tengai PARTS LIST

## Radiator

ITEM NAME	PART NUMBER	QUANTITY
GASKET,RESERVOIR TANK CAP (Ref # 11009)	11009-1145	1
CAP (Ref # 11012)	11012-1084	1
SCREEN (Ref # 14037)	14037-1088	1
RELAY-ASSY (Ref # 27002)	27002-1051	1
SWITCH,FAN (Ref # 27010)	27010-1167	1
RADIATOR (Ref # 39060)	39060-1074	1
HOSE-COOLING (Ref # 39062)	39062-1125	1
HOSE-COOLING,HEAD-RADIATOR (Ref # 39062A)	39062-1217	1
HOSE-COOLING,RESERVOIR (Ref # 39062B)	39062-1220	1
HOSE-COOLING,RADIATOR-PUMP (Ref # 39062C)	39062-1243	1
RESERVOIR (Ref # 43078)	43078-1083	1
CAP-ASSY-PRESSURE (Ref # 49085)	49085-1003	1
FAN-ASSY (Ref # 59502)	59502-1082	1
SCREW,6X12 (Ref # 92009)	92009-1480	1
NUT (Ref # 92015)	92015-1487	4
NUT,6MM (Ref # 92015A)	92015-1758	1
COLLAR (Ref # 92027)	92027-1183	3
CLAMP,TUBE (Ref # 92037)	92037-147	3
DAMPER (Ref # 92075)	92075-1352	3
BOLT,FLANGED,6X16 (Ref # 92150)	92150-1506	3
CLAMP,COOLING HOSE (Ref # 92170)	92170-1033	4
BOLT-FLANGED (Ref # 130)	130J0612	3
BOLT-FLANGED (Ref # 130A)	130J0620	1
BOLT-FLANGED,6X25 (Ref # 130B)	130J0625	2