

1991 Tengai PARTS DIAGRAM

Head Lamp

F2710

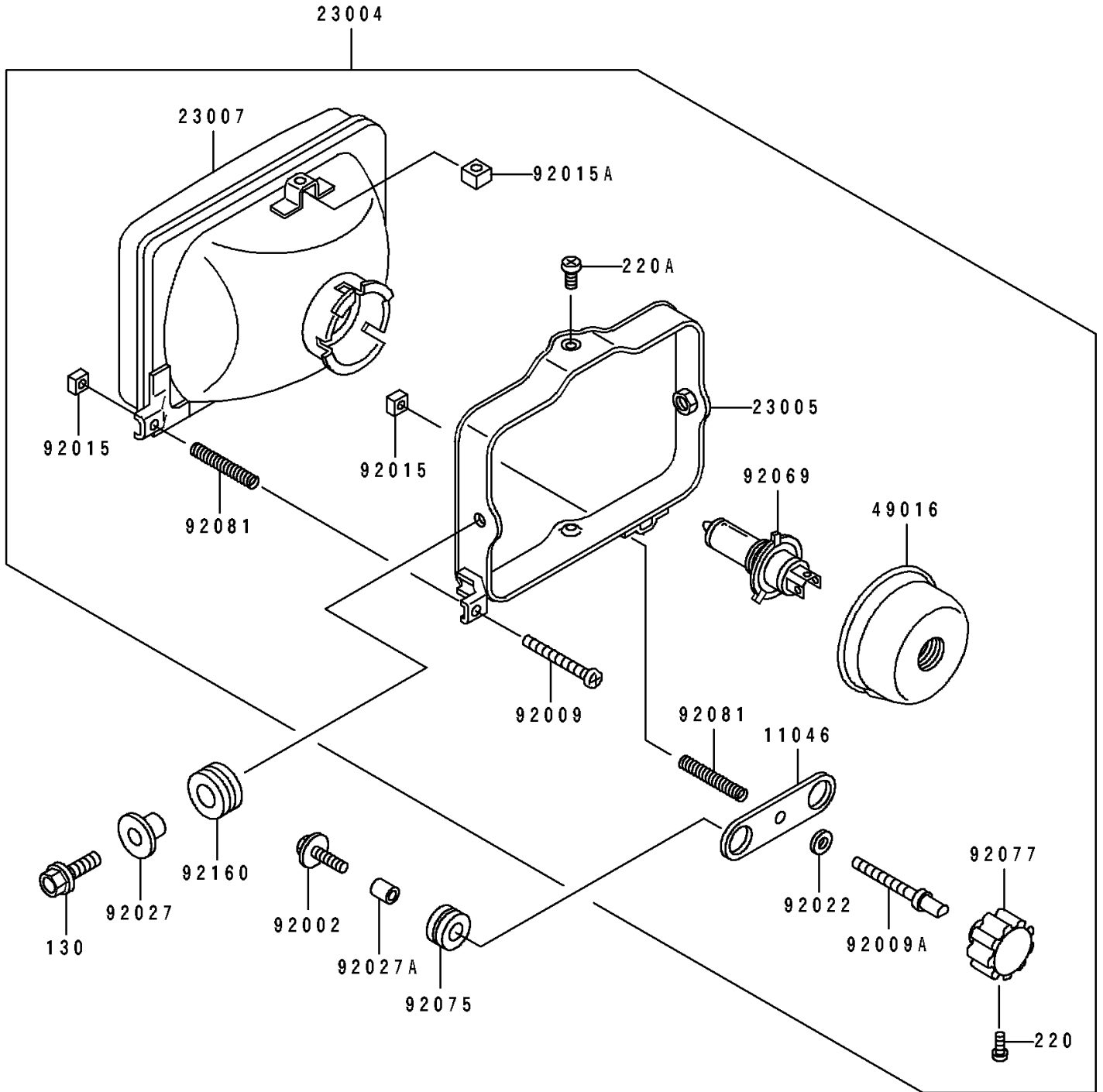

1991 Tengai PARTS LIST

Head Lamp

ITEM NAME	PART NUMBER	QUANTITY
BRACKET,HEAD LAMP (Ref # 11046)	11046-1510	1
LAMP-HEAD (Ref # 23004)	23004-1277	1
BODY-COMP-HEAD LAMP (Ref # 23005)	23005-1098	1
LENS-COMP,HEAD LAMP (Ref # 23007)	23007-1226	1
COVER-SEAL,HEAD LAMP (Ref # 49016)	49016-1046	1
BOLT,6X25 (Ref # 92002)	92002-1135	2
SCREW,4X52 (Ref # 92009)	92009-1033	1
SCREW,FOCUS ADJUSTING (Ref # 92009A)	92009-1565	1
NUT,4MM,FOCUS ADJUST (Ref # 92015)	23020-018	2
NUT,5MM (Ref # 92015A)	92015-1157	2
WASHER,5.1X10X1.0 (Ref # 92022)	92022-1977	1
COLLAR,L=14 (Ref # 92027)	92027-1134	2
COLLAR,6.8X10X12 (Ref # 92027A)	92027-162	2
BULB,12V 60/55W,H4 (Ref # 92069)	92069-1002	1
DAMPER (Ref # 92075)	92075-209	2
KNOB,HEAD LAMP (Ref # 92077)	92077-1010	1
SPRING,FOCUS ADJUSTING (Ref # 92081)	92081-1701	2
DAMPER (Ref # 92160)	92160-1007	2
BOLT-FLANGED,8X25 (Ref # 130)	130B0825	2
SCREW-PAN-CROS (Ref # 220)	220B0312	1
SCREW-PAN-CROS (Ref # 220A)	220D0510	2