

1991 Tengai PARTS DIAGRAM

Electrical Equipment

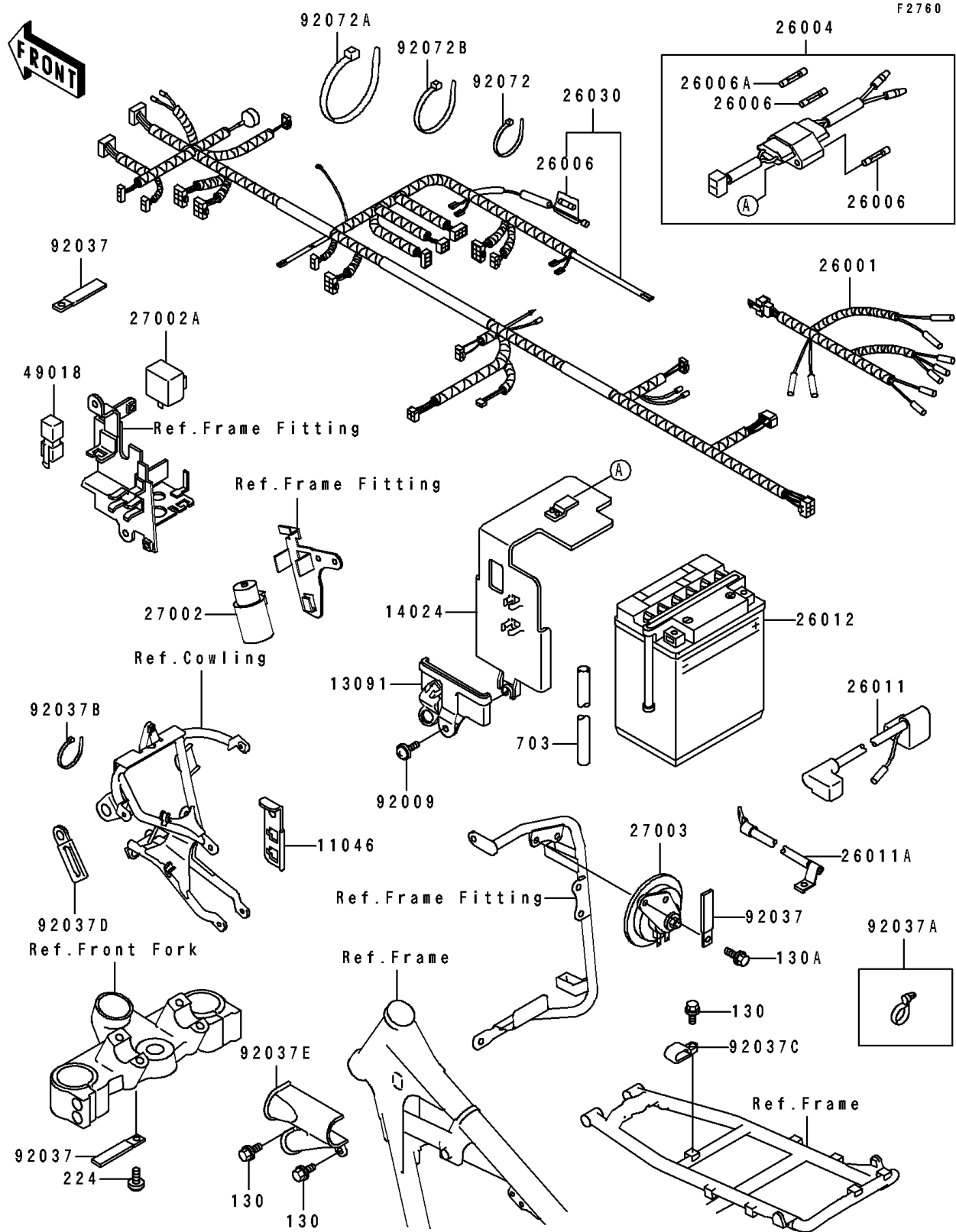

1991 Tengai PARTS LIST

Electrical Equipment

ITEM NAME	PART NUMBER	QUANTITY
BRACKET (Ref # 11046)	11046-1791	1
HOLDER,BATTERY COVER (Ref # 13091)	13091-1484	1
COVER,BATTERY (Ref # 14024)	14024-1375	1
HARNESS,RR (Ref # 26001)	26001-1822	1
FUSE-ASSY (Ref # 26004)	26004-1076	1
FUSE,10A,L=30 (Ref # 26006)	26006-1002	4
FUSE,20A,L=30 (Ref # 26006A)	26006-1056	1
WIRE-LEAD,BATTERY(+) (Ref # 26011)	26011-1386	1
WIRE-LEAD,BATTERY(-) (Ref # 26011A)	26011-1387	1
BATTERY,12V 14AH,FB14L-A2 (Ref # 26012)	26012-1219	1
HARNESS,MAIN (Ref # 26030)	26030-1004	1
RELAY-ASSY (Ref # 27002)	27002-1051	1
RELAY-ASSY,TURN SIGNAL (Ref # 27002A)	27002-1053	1
HORN (Ref # 27003)	27003-1273	1
DIODE (Ref # 49018)	49018-1052	1
SCREW,6X10 (Ref # 92009)	92009-1402	1
CLAMP,WIRING HARNESS (Ref # 92037)	92037-1069	3
CLAMP,HOSE (Ref # 92037A)	92037-1163	3
CLAMP (Ref # 92037B)	92037-1173	1
CLAMP (Ref # 92037C)	92037-1608	1
CLAMP (Ref # 92037D)	92037-1780	2
CLAMP,HARNESS (Ref # 92037E)	92037-1906	1
BAND,L=185 (Ref # 92072)	92072-1195	3
BAND,L=365 (Ref # 92072A)	92072-1197	5
BAND,L=250 (Ref # 92072B)	92072-1237	5
BOLT-FLANGED,6X10 (Ref # 130)	130B0610	3
BOLT-FLANGED,6X14 (Ref # 130A)	130D0614	2
SCREW-PAN-WP-CROS (Ref # 224)	224B0508	1
TUBE-RUBBER,8X12X580 (Ref # 703)	703A08580	1