

1988 Mojave 110E PARTS DIAGRAM

Cylinder Head

E1111-0190

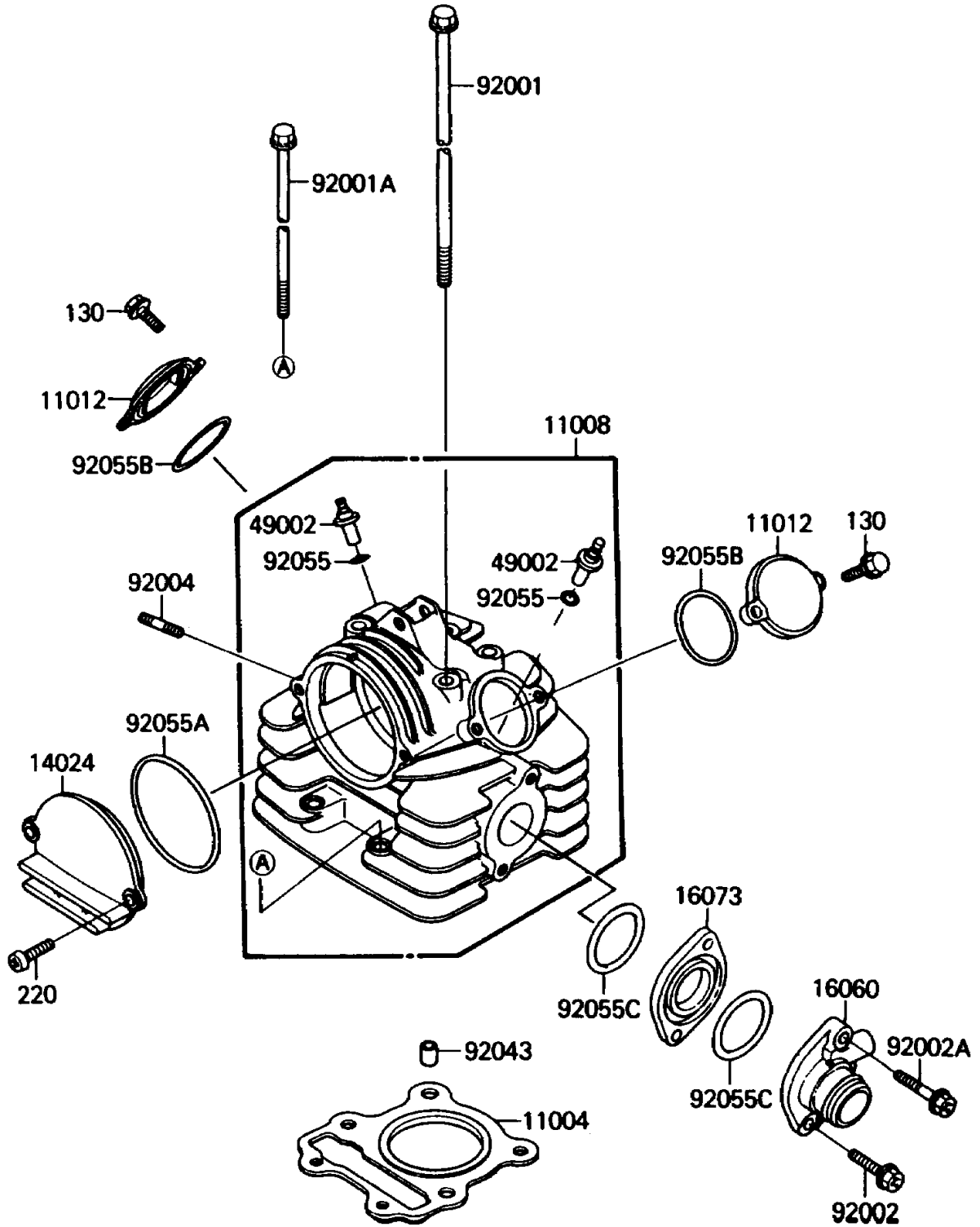

1988 Mojave 110E PARTS LIST

Cylinder Head

ITEM NAME	PART NUMBER	QUANTITY
GASKET-HEAD (Ref # 11004)	11004-1163	1
HEAD-COMP-CYLINDER (Ref # 11008)	11008-1158	1
CAP,VALVE ADJUSTING (Ref # 11012)	11012-1560	2
COVER,SPROCKET (Ref # 14024)	14024-1358	1
PIPE-INTAKE (Ref # 16060)	16060-1009	1
INSULATOR,INTAKE PIPE (Ref # 16073)	16073-1016	1
GUIDE-VALVE (Ref # 49002)	49002-1056	2
BOLT,FLANGED,8X196 (Ref # 92001)	92001-1838	4
BOLT,FLANGED,6X106 (Ref # 92001A)	92001-1839	2
BOLT,6X25 (Ref # 92002)	92002-1235	1
BOLT,6X30 (Ref # 92002A)	92002-1295	1
STUD,6X18 (Ref # 92004)	92004-1127	2
PIN,8.2X10X14 (Ref # 92043)	92043-1264	2
RING-O,VALVE GUIDE (Ref # 92055)	92055-1177	2
RING-O,68.6MM (Ref # 92055A)	92055-1178	1
RING-O,ADJUST CAP (Ref # 92055B)	92055-1231	2
RING-O,30MM (Ref # 92055C)	92055-1232	2
BOLT-FLANGED (Ref # 130)	130Y0620	4
SCREW-PAN-CROS (Ref # 220)	220X0620	2