

1988 Mojave 110E PARTS DIAGRAM

Footrests

F2160-0159

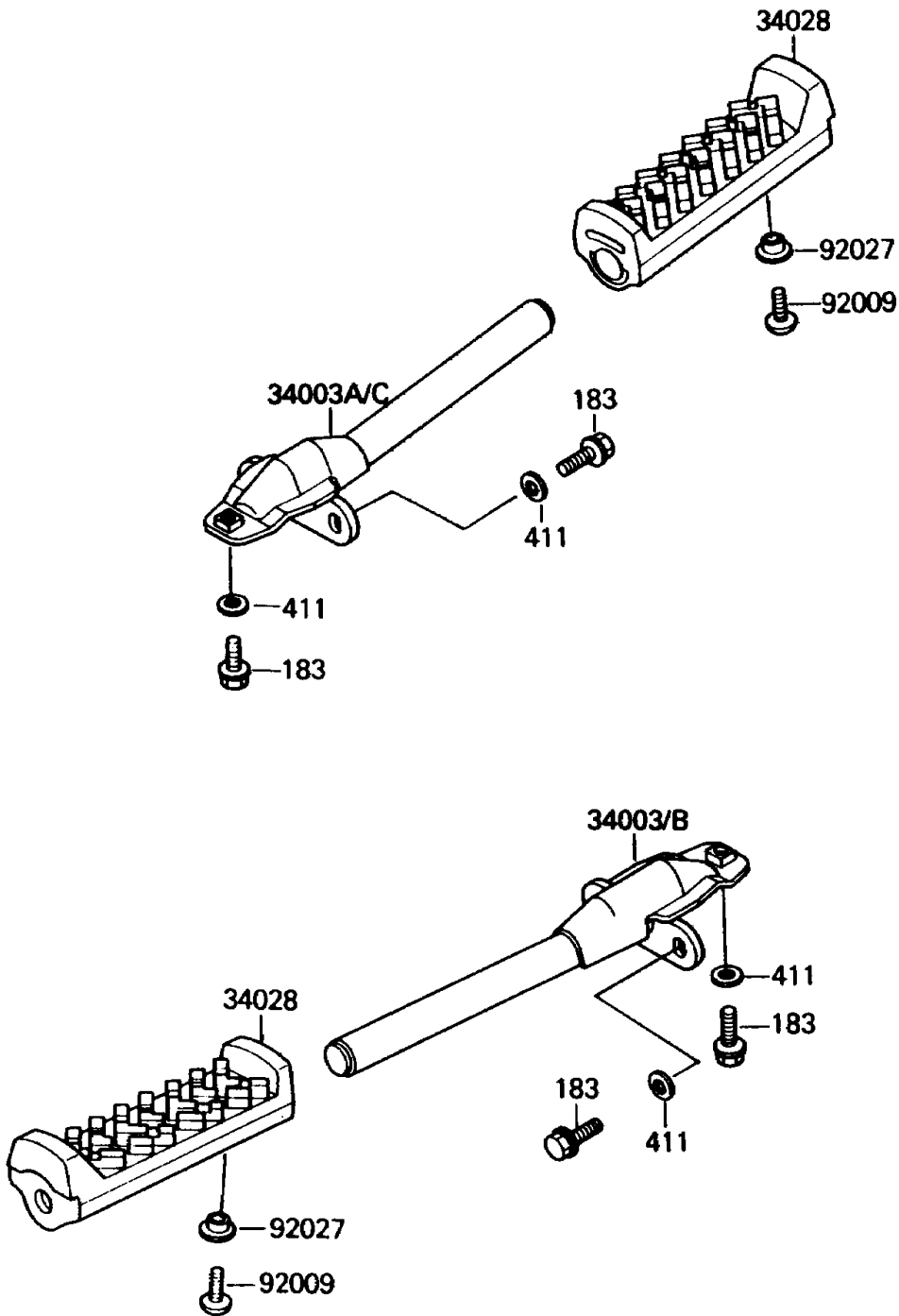

1988 Mojave 110E PARTS LIST

Footrests

ITEM NAME	PART NUMBER	QUANTITY
HOLDER-STEP,LH (Ref # 34003B)	34003-1307	1
HOLDER-STEP,RH (Ref # 34003C)	34003-1308	1
STEP (Ref # 34028)	34028-1156	2
SCREW (Ref # 92009)	92009-1166	4
COLLAR,L=5 (Ref # 92027)	92027-4020	4
BOLT-UPSET-WS-SMALL (Ref # 183)	183H0820	6
WASHER-PLAIN (Ref # 411)	411E0800	6