

1988 Bayou 185 PARTS DIAGRAM

Crankcase

E1411-0142

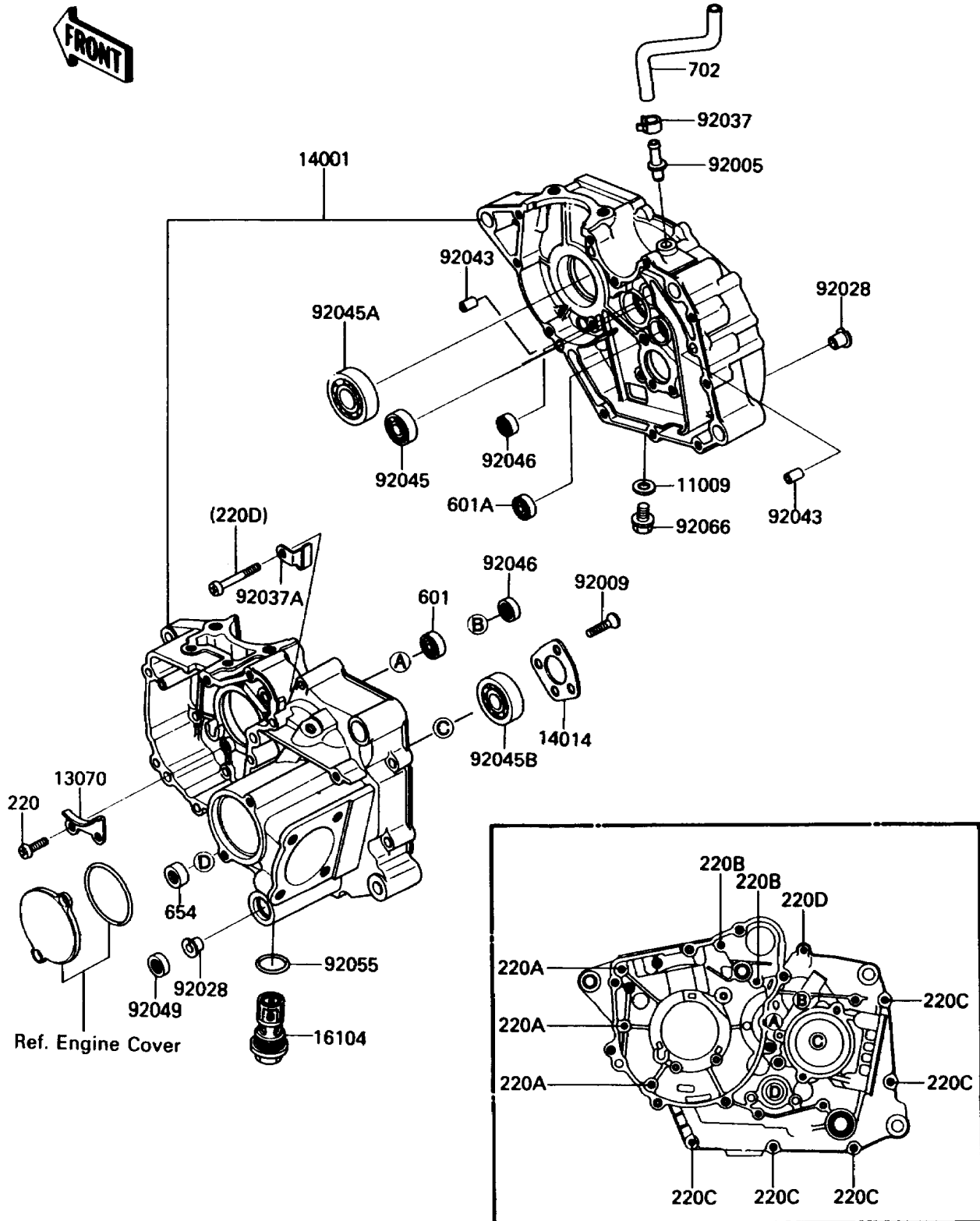

1988 Bayou 185 PARTS LIST

Crankcase

ITEM NAME	PART NUMBER	QUANTITY
GASKET,12X22X2,DRAIN PLUG (Ref # 11009)	92065-097	1
GUIDE,CAM CHAIN (Ref # 13070)	13070-1110	1
SET-CRANKCASE (Ref # 14001)	14001-5212	1
PLATE-POSITION (Ref # 14014)	14014-1055	1
FILTER-COMP (Ref # 16104)	16104-1055	1
FITTING,BREATHER PIPE (Ref # 92005)	92005-1124	1
SCREW,6X14 (Ref # 92009)	92009-1349	4
BUSHING (Ref # 92028)	92028-1386	2
CLAMP (Ref # 92037)	92037-1181	1
CLAMP (Ref # 92037A)	92037-1724	1
PIN,DOWEL,6.3X8X14 (Ref # 92043)	92042-007	2
BEARING-BALL,#6204 (Ref # 92045)	92045-1032	1
BEARING-BALL,6305JR2C3 (Ref # 92045A)	92045-1120	1
BEARING-BALL,TMB304CCM (Ref # 92045B)	92045-1142	1
BEARING-NEEDLE,HMK1515B (Ref # 92046)	92046-060	2
SEAL-OIL,TB13225.5 (Ref # 92049)	92051-005	1
RING-O,25.7X2.4 (Ref # 92055)	92055-1136	1
PLUG,OIL DRAIN,12X15 (Ref # 92066)	92066-1174	1
SCREW-PAN-CROS,6X14 (Ref # 220)	220B0614	2
SCREW-PAN-CROS,6X60 (Ref # 220A)	220B0660	3
SCREW-PAN-CROS,6X70 (Ref # 220B)	220B0670	2
SCREW-PAN-CROS (Ref # 220C)	220X0635	5
SCREW-PAN-CROS (Ref # 220D)	220X0650	1
BEARING-BALL (Ref # 601)	601A6202Z	1
BEARING-BALL,#6202C3 (Ref # 601A)	601B6202	1
SEAL OIL (Ref # 654)	654B14257	1
TUBE-RUBBER (Ref # 702)	702A08400	1