

1991 Bayou 220 PARTS DIAGRAM

Oil Pump

E1710-0088

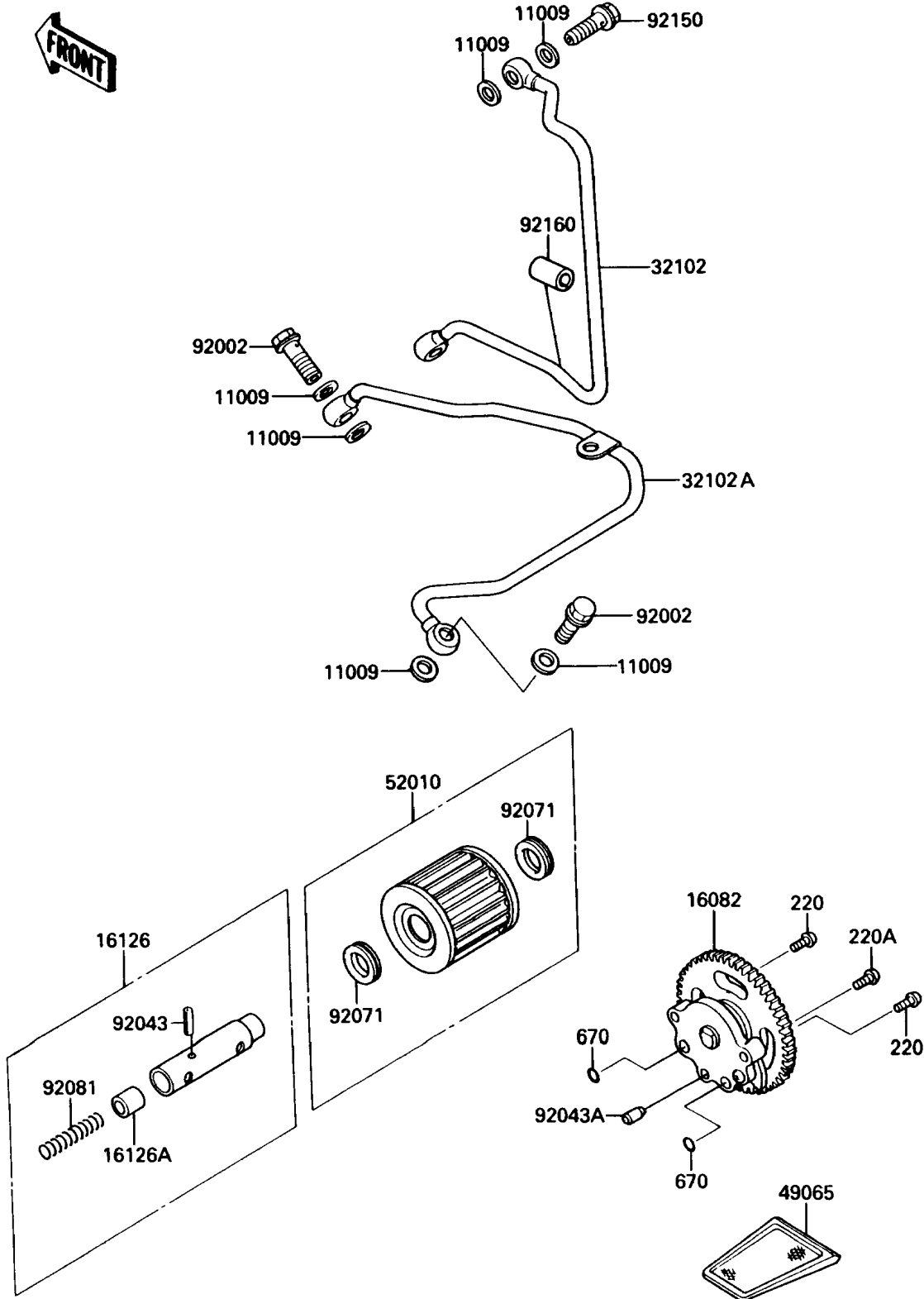

1991 Bayou 220 PARTS LIST

Oil Pump

ITEM NAME	PART NUMBER	QUANTITY
SCREW-PAN-CROS,6X20,WHITE (Ref # 220)	220B0620	2
SCREW-PAN-CROS,6X30 (Ref # 220A)	220B0630	1
O RING,10MM (Ref # 670)	670B1510	2
GASKET,OIL PIPE,8.2X14X1.0 (Ref # 11009)	11009-1344	8
PUMP-ASSY-OIL (Ref # 16082)	16082-1090	1
PISTON-ASSY,VALVE,BY-PASS (Ref # 16126)	16156-002	1
VALVE (Ref # 16126A)	92136-002	1
PIPE,CYLINDER HEAD (Ref # 32102)	32102-1594	1
PIPE,TRANSMISSION (Ref # 32102A)	32102-1595	1
FILTER-OIL (Ref # 49065)	49065-1058	1
ELEMENT-OIL FILTER (Ref # 52010)	16099-004	1
BOLT,BANJO,8X22 (Ref # 92002)	92002-1359	3
PIN,SPRING,2.2X13.5 (Ref # 92043)	92043-123	1
PIN,6.2X8X14 (Ref # 92043A)	92043-1263	1
GROMMET,OIL FILTER (Ref # 92071)	92071-101	2
SPRING,PISTON (Ref # 92081)	92081-043	1
BOLT,BANJO,8X25 (Ref # 92150)	92002-1987	1
DAMPER,4.5X11X20 (Ref # 92160)	92160-1074	1